

PRINCIPLE 11

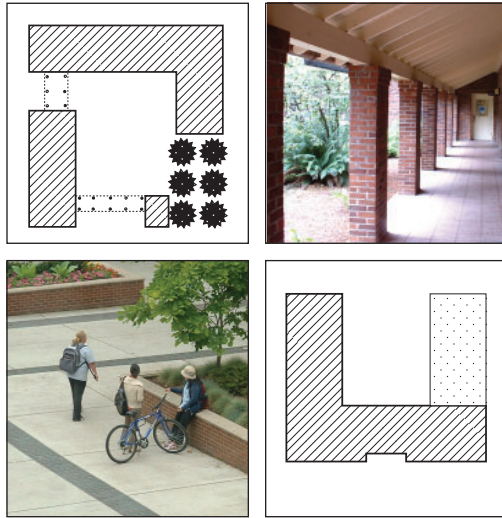

PATTERNS

PRINCIPLE 11: PATTERNS

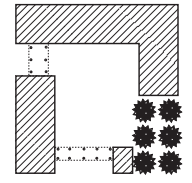

Principle

Patterns establish a means of articulating commonly held values as they pertain to the campus environment and design. Patterns ideally function together as words in a sentence, creating a cohesive whole built on a common design language, the “pattern language.”

To achieve effective and meaningful dialog about important campus design issues, all construction projects shall consider the patterns below.

Patterns

Each pattern shall be considered during project design, as described in this chapter.

Patterns are statements that describe and analyze design issues and suggest ways in which those issues might be resolved.

The term “pattern language” is best known from the book *A Pattern Language*.¹² Its Principle author, Christopher Alexander, helped the University of Oregon develop its planning process in the early 1970s. A pattern is “any general planning principle, which states a clear problem that may occur repeatedly in the environment, states the range of contexts in which this problem will occur, and gives the general features required by all buildings or plans which will solve this problem” (*The Oregon Experiment*, page 177). These patterns ideally function together as words in a sentence, creating a cohesive whole built on a common design language, the “pattern language.”

The process and its constituent components are described more fully in the book *The Oregon Experiment*. The purpose of developing a pattern language was to provide a non-technical vocabulary of design principles that would allow building users to communicate effectively with the planners and designers of those buildings.

The university must maintain a balanced perspective on the physical development of the campus. It must be able to respond quickly to opportunities for facilities improvements as they emerge. It also must employ long-range planning and emphasize the importance of long-term continuity in development decisions. The use of patterns, as opposed to a “fixed image” master plan, helps to achieve this goal. Patterns articulate long-lasting shared traditions and understandings yet adapt well to changing development needs.

Application of Patterns in the Design Process: Project Pattern Lists

- (a) All user groups shall review the Campus-wide Pattern List (page 93) and select patterns with issues relevant to their projects (and add new patterns as appropriate; see (c) below). Every project pattern list must include those patterns highlighted in bold-face type. At the beginning of a project’s design process Campus Planning and Facilities Management will work with the project sponsor to create a draft project pattern list. The Campus Planning Committee, during its review of the project’s process (see “Principle 1: Process and Participation,” page 21), will comment on the appropriateness and completeness of the list of patterns selected.

¹² Christopher Alexander et al., *A Pattern Language* (New York: Oxford UP, 1977).

- (b) Each pattern on the Campus-wide Pattern List shall be considered as the project is designed. If any patterns in bold typeface are not implemented, the reasons for their omission are to be reported to the Campus Planning Committee during its schematic design review. (See "Principle 1: Process and Participation", page 21.)
- (c) As the user group defines the project, the list may grow to include new patterns written to address specific issues the user group wishes the project architect to consider or to include other patterns not previously identified. The list may continue to grow during project design as the result of new or newly added patterns.
- (d) In most cases, literal interpretation of a pattern should be avoided. The pattern is intended to help identify the essence of an issue that needs to be considered and to suggest ways in which the issue might be resolved. In some cases it is possible that although the problem is properly identified, the solution suggested by the pattern may not be appropriate. Such cases call for an alternate means of resolving the issue.

The accompanying graphics are provided for illustrative purposes only. The pattern text takes precedence.

Campus-wide Pattern List: A Pattern Language for the University of Oregon

The following list is arranged roughly from global issues to specific issues.

Highlighted patterns must be considered for every project.

The full text of each pattern, with patterns arranged in alphabetical order, follows this list.

LARGE SCALE CAMPUS

This first set of patterns defines how the campus is formed at the greatest scale and looks at the composition of the entire campus.

Campus Trees
 Good Neighbor
 Historic Landscapes
 Main Gateways
Open-space Framework
 Open University
 Outdoor Classroom
 Promenade
 Quadrangles and the Historic Core
 Student Housing
Sustainable Development
Universal Access
 University Shape and Diameter
Welcoming to All

TRANSPORTATION

This set of patterns defines the transportation systems (including pathways) of the entire campus.

Bike Paths, Racks, and Lockers
 Hierarchy of Streets
Local Transport Area
 Looped Local Roads
 Paths and Goals
 Path Shape
 Pedestrian Pathways
 Peripheral Parking
 Road Crossings
 Shielded Parking and Service Areas
 Small Parking Lots in Campus Core
 Spillover Parking

SITE ARRANGEMENT

This set of patterns informs how buildings should be arranged to become a part of the campus.

Access to Water
 Accessible Green
 Activity Nodes
Building Complex
Connected Buildings
Existing Uses/Replacement
 Family of Entrances
 Local Sports
Main Building Entrance
Positive Outdoor Space
 Public Outdoor Room
Quiet Backs
 Research Ties
 Seat Spots
Site Repair
 Sitting Wall
 Small Public Squares
South Facing Outdoors
 Tree Places
Use Wisely What We Have
 Water Quality

BUILDING DESIGN

This set of patterns informs how each building should be designed.

Arcades
Architectural Style
 Building Character and Campus Context
Building Hearth
 Classroom Distribution
 Enough Storage
 Fabric of Departments
 Faculty-Student Mix
Flexibility and Longevity
Four-story Limit
Future Expansion
 Materials and Operations
 No Signs Needed
 Office Connections
Operable Windows
Organizational Clarity
 Places to Wait
 Pools of Light
 Public Gradient
Quality of Light
Wholeness of Project
Wings of Light

Campus-wide Pattern Descriptions

Highlighted patterns must be considered for every project.

An asterisk (*) identifies patterns that also are principles or principle refinements. They are restated here as patterns to ensure their consideration during the design process. Refer to each principle for exact requirements.

Refer to separate subject plans such as the Campus Tree Plan and the Development Policy for the East Campus Area for additional patterns.



Access to Water

People have a fundamental yearning for bodies of water. Hearing it, being near it, and touching it are things people like to do.

THEREFORE: When possible create water features that allow campus users to listen to and touch water. These could be as simple as standing pools or as dramatic as water falling from a high spot.



Accessible Green

When people work extremely close to large open green areas, they visit them and use them often; but even a fairly short distance will discourage them.

THEREFORE: Provide a green outdoor space, for passive or active use, that is at least 50,000 square feet in area and at least 100 feet across in the narrowest direction, within 600 feet of every on-campus building.

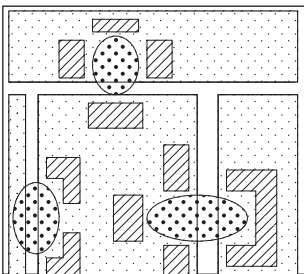

Activity Nodes

When buildings are spread evenly across campus, they do not generate small centers of public life around them. They do nothing to help the various “neighborhoods” on the campus to coalesce.

THEREFORE: When locating buildings, place them in conjunction with other buildings to form small nodes of public life. Create a series of these nodes throughout the university, in contrast to the quiet, private outdoor spaces between them, and knit these nodes together with a network of pedestrian paths.



Arcades

Arcades at the edges of buildings—partly inside and partly outside the building—play a vital role in the way group territory and the society-at-large interact. Our climate is especially suited for sitting or walking outside under cover on a rainy day. South-facing arcades create wonderful micro-climates during most of the year.

THEREFORE: Whenever possible, create arcades along the sides of buildings or between their wings, and open building interiors to these arcades. As possible, knit these arcades together with campus paths so they form a semi-covered system of paths throughout the campus.

Architectural Style* [See “Principle 7: Architectural Style and Historic Preservation” on page 71 for requirements.]

The continuity of the university’s campus environment is materially affected by the character and architectural styles of the buildings that are constructed.

THEREFORE: Make the design of new buildings compatible and harmonious with the design of adjacent buildings (on and off campus), though they need not (and in some cases should not) mimic them.



Bike Paths, Racks, and Lockers* [See “Principle 9: Transportation” on page 81 for requirements.]

Bikes are cheap, healthy, good for the environment, and a critical component to the university’s transportation system. They are threatened by cars on streets, they can be a threat to pedestrians on pedestrian paths, and they need secure, convenient, and attractive storage.

THEREFORE: Consider how each development or building can contribute to the campus-wide system of paths, racks, and lockers. Pay particular attention to the location of racks and lockers to ensure their appropriate adjacency to the path system and their popularity.



Building Character and Campus Context

Individuals develop impressions about a building immediately upon seeing it, and these impressions affect their perception of the building’s occupants and their endeavors. The image of a building is defined also by its surrounding campus fabric and vice versa.

THEREFORE: Ensure that the exterior character clearly communicates the unique nature of the facility while respecting and enhancing the context of the surrounding campus. The building should attract students and encourage them to use the resources and services offered within.



Building Complex

The human scale vanishes in enormous buildings. People who use them stop identifying the staff who work there as personalities, and the staff feel like small cogs in a greater machine.

THEREFORE: To maintain human scale in campus buildings, make them small, perhaps no larger than 100,000 gross square feet (with some notable exceptions such as libraries and recreation facilities) and not more than three or four stories high. If more space is needed, the buildings should be conceived as a collection connected by arcades or bridges defining and embracing outdoor spaces.

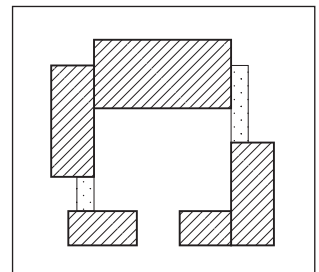

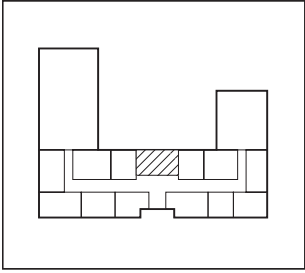

Building Hearth

When a building is just a collection of rooms without a focus, there is little chance for a sense of community to develop, and the possibility of an open exchange of ideas diminishes.

THEREFORE: Create a social hearth for every building. Place the hearth at the building’s perceived center of gravity and beside a path that everyone uses. Within the hearth provide space for a lounge, mail, coffee, supplies, student information, etc. Additional hearths for departments may be appropriate as well once the building hearth is accommodated.

Campus Trees

The UO campus is an arboretum and a tree identification classroom. Not only are there many unusual trees, memorial trees, and otherwise special trees, but trees also play an important part in the formation of open spaces (for example, by creating edges). Building projects often are considered for sites that are occupied by trees, setting up a conflict between programmatic and aesthetic needs.



THEREFORE: Whenever possible, build in ways that preserve or relocate trees. If any trees must be removed, follow the requirements of the university’s *Campus Tree Plan*.

Classroom Distribution

Intimate seminars for ten students do not work well in huge classrooms; and classrooms beyond a seven-minute walking circle cannot be reached on foot during the ten minutes between classes.



THEREFORE: Construct classrooms so that each type (classified by number of seats) is distributed among the total classroom pool according to the following percentages:

Classroom type by numbers of seats	Percentage of classrooms of this type
0 - 15	3%
16 - 30	30%
31 - 60	39%
61 - 90	11%
91 - 150	12%
151 - 300	4%
300 and up	1%

Reserve the center part of campus for classrooms so students and faculty can walk easily to their next classes.

Connected Buildings

Isolated buildings can be symptoms of a disconnected campus community.

THEREFORE: Consider connecting new buildings to existing buildings wherever possible. Try to form new buildings as continuations of older buildings and, in so doing, use the arrangement of the buildings to make pleasant outdoor spaces.

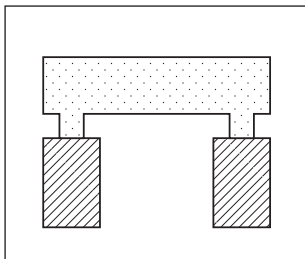

Enough Storage

Lack of storage space can turn staff work spaces into storage areas and cause staff to waste valuable time locating and retrieving stored items.

THEREFORE: Provide space in each program for storage of equipment and materials, and provide central storage for shared items. Centralized storage, as well as storage for separate programs, may be provided either as shared or as discrete spaces depending on specific program needs.



Existing Uses/Replacement* [See “Principle 5: Replacement of Displaced Uses” on page 61 for requirements.]

All university uses are important to the university. A new use must not benefit at the expense of an existing use.

THEREFORE: All plans for new development (buildings, landscape, or remodeling projects) shall keep existing uses intact by developing plans and identifying funding for their replacement.



Fabric of Departments

Overemphasis on the individuality of departments helps to fragment knowledge by keeping it in watertight compartments. Yet each department requires its own identity.

THEREFORE: Give each department a clearly identified home base, but spread the parts of the department within a radius of about 500 feet so they interlock with parts of other departments. No one of these parts should contain less than five faculty offices.

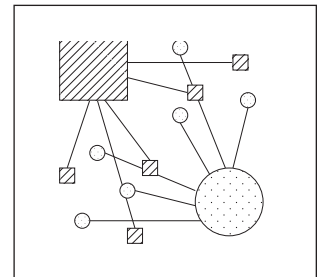

Faculty-Student Mix

Students and faculty can benefit most from each other if they are able to develop mutual respect and common interests within small groups. Learning and research cannot flourish without the sustained, informal contacts that occur within such groups.

THEREFORE: Cluster student workplaces around faculty offices. Give each cluster a common entrance and a common area which contains seats, books, journals, microwave, seminar table, and the like.

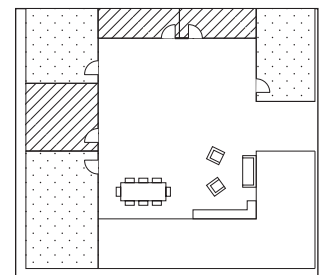

Family of Entrances

When people enter a complex of buildings, they may experience confusion unless the whole collection of entries is laid out so they can see the entrance to the place they are going.

THEREFORE: Lay out the entrances to form a family. This means:

1. They form a group, are visible together, and each is visible from all the others.
2. They are all clearly recognizable as entrances.

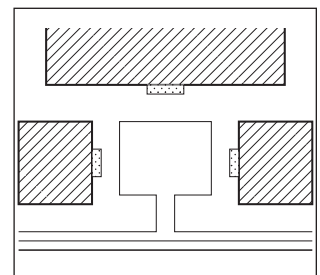

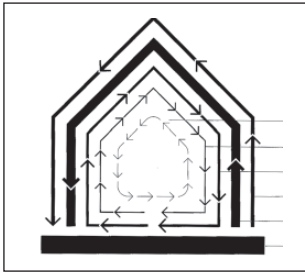
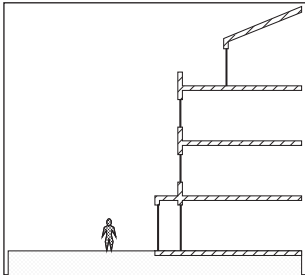

Image from *How Buildings Learn* by Stewart Brand (1994), page 13.

Flexibility and Longevity

Even today's best building will eventually be disliked if it is poorly planned for the future or poorly built. If it can't adapt to programmatic change, it will either frustrate its users or be demolished.

THEREFORE: Provide flexibility through several concepts. First, make the least flexible systems, such as structure and mechanical systems, long lasting and carefully planned for general usefulness independent of programmatic need. Second, avoid designing space that is over tailored to a specific use. For example, make sure that a computer lab may have a future life as a classroom, a lounge, or a learning center. Third, make interior partitions relatively "soft" to allow future removal without major disruption. For example, put electrical panels, major ducts, and electrical risers on corridor or exterior walls. Finally, provide spare capacity in critical building systems such as electrical power, air handling, and fire alarms so that future intensification of use can occur without total revision of existing systems.



Four-story Limit

An important aspect of the campus's beauty is access to sunlight, views of the sky, and human scale.

THEREFORE: Keep the majority of buildings four stories high or less. It is possible that a few buildings may exceed this limit, but strong consideration must be given to the resultant shadows and skyline to ensure the beauty of the campus and the importance of the individual.

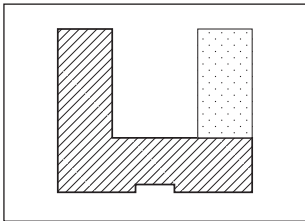

Future Expansion

Buildings inevitably change and expand over time to adapt to changing user needs.

THEREFORE: Consider the possibility of future expansion and change when designing a new building or addition.



Good Neighbor

It's easy to be so focused on making campus projects as wonderful as possible for their users that we ignore their impacts on our neighbors.

THEREFORE: Consider each project's impacts on neighbors and community. For example, what will the building look like from outside the campus boundaries? What parking impacts may spill over into other areas?

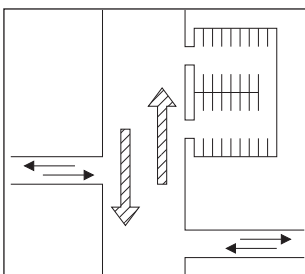

Hierarchy of Streets

Campus traffic may seek short cuts through residential areas near the campus if more appropriate alternatives don't exist.

THEREFORE: Discourage auto traffic on streets that do not connect to arterials or neighborhood collectors, and encourage traffic on streets that do.

Historic Landscapes [See “Principle 7: Architectural Style and Historic Preservation” on page 71 for requirements.]

The campus landscape is a record of its time, place, and use and is a repository of significant local and state history. When characteristic features of a historic landscape are lost, the integrity and ability of the landscape to tell this story is destroyed and the campus context is diminished.

Therefore: Protect and steward historic landscapes in the context of an evolving university. Select treatment approaches (preservation, rehabilitation, restoration, and continuation) based upon historic significance, integrity, and contemporary goals for the space. As the campus expands, consider integrating historic landscape characteristics into new areas to enhance a sense of campus-wide order and cohesiveness. Refer to the Campus Heritage Landscape Plan.



Local Sports

Students cannot get a good education in a place that runs like a factory with a hectic work pace and without the chance for a relaxing physical diversion.

THEREFORE: Arrange opportunities for recreation on campus so that every point is within 600 feet of a place designed for sports and leisure—a swimming pool, gym, basketball hoop, tennis courts, open field, etc.



Local Transport Area

The impact of the car on social life is devastating: it keeps us off the streets and far away from one another. The first step in bringing the car under control is to stop using it for local trips.

THEREFORE: Embed the university in a local transport area one to two miles in diameter. Except for very special cases, encourage local trips within this area to be made on foot, bikes, or scooters. Adapt paths and roads to these modes of travel, and keep the streets slow and circuitous. At the edge of the local transport area create access to transit and car-storage areas.



Looped Local Roads

Through traffic destroys the tranquility and the safety of pedestrian areas. This is especially true in university districts, where the creation of quiet precincts is crucial to scholarship.

THEREFORE: To bring the traffic and the pedestrian world into the right balance, make the local roads that serve the area form a system of loops or cul-de-sac, so that through traffic is impossible.

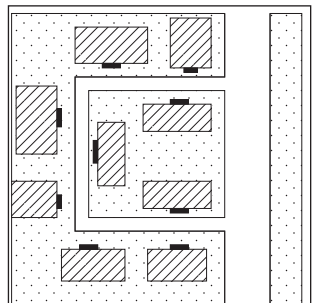

Main Building Entrance

Placing the main entrance(s) is perhaps the single most important step taken during the evolution of a building plan.

THEREFORE: Place the main entrance(s) of the building at a point immediately visible from the main avenues of approach, and give it a bold shape in the front of the building.

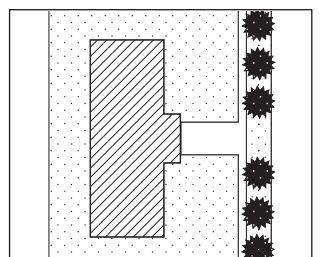



Main Gateways

Any part of an area—large or small—that is to be identified by its users as a precinct of some kind will be reinforced or made more distinct and more vivid if the paths crossing its boundary are marked by gateways.

THEREFORE: Mark every campus boundary that has important meaning with great welcoming gateways where the major entering paths cross the boundary.



Materials and Operations

Poorly selected materials, inappropriate energy strategies, and complex facilities designs all can contribute to high operating costs. Maintenance not only is a major component of the operating budget but also is a health issue.

THEREFORE: Designers should select materials that are easy to maintain and healthy, creating buildings that are energy efficient and easy to add on to or modify later.

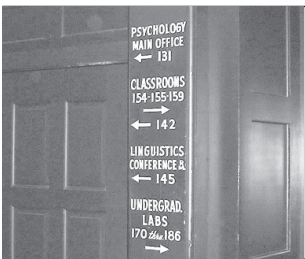

No Signs Needed

Some buildings seem to have been planned to need signs so that people can find their way. Alternatively, a building can be designed to be self guiding, making it as easy as possible to negotiate through.

THEREFORE: Plan buildings to be as self guiding as possible so the signs are used to supplement good planning rather than to overcome bad planning.

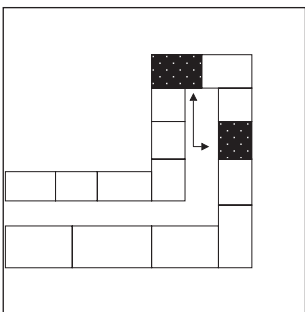

Office Connections

If two parts of an institute, center, department, or administrative unit are too far apart, people will not move between them as often as they need to; if the parts are more than one floor apart, there will be almost no communication between them.

THEREFORE: To establish distances between offices within the same organization, calculate the number of trips per day made between each of the two offices and ensure that those with frequent contact are located on the same floor within a reasonable walking distance of each other.

Open-space Framework* [See “Designated Open Spaces” in “Principle 2: Open-space Framework” on page 37 for requirements.]

The University of Oregon campus is organized as a system of quadrangles, malls, pathways, and other open spaces and their landscapes. This organizational framework not only functions well, but also serves as a physical representation of the university’s heritage.

THEREFORE: Build in ways that improve the existing open-space framework and extend it as possible.

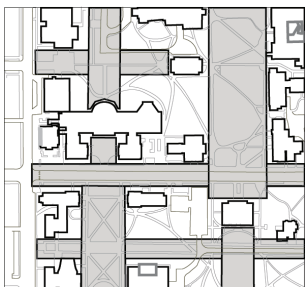

Open University

When a university campus is separated from the town by a hard boundary, students and townspeople tend to be isolated from each other; in a subtle way the university takes on the character of a glorified high school.

THEREFORE: Ensure that the campus edges are soft and the gateways marking the boundary between university and town are welcoming and inviting to townspeople rather than shunning. For students, make easy connections to the town so they are encouraged to visit the town often. Refer to “Principle 2: Open-space Framework” on page 37 for more on edges.

Operable Windows

People who work for several hours each day in confined spaces such as offices benefit from access to fresh outside air. Current research indicates that such access also improves educational achievement. Additionally, energy savings accrue when users are able to adjust their own environments by opening windows and letting in outside air.

THEREFORE: In the absence of compelling reasons to the contrary, all exterior windows of university buildings must be able to be opened wholly or in part.

Organizational Clarity

Buildings whose organization is difficult to understand are difficult to use. First-time visitors are easily confused, and long-time users get frustrated.

THEREFORE: Create a clear organization and circulation scheme for the building. Ideally each floor would broadly resemble the others. Provide cues through visible landmarks, interior day lighting, and interior vistas that clearly convey how the building’s parts relate and join one another.

Outdoor Classroom

Many campus open spaces serve as vital “classrooms.” Many outdoor-classroom functions require open, sunny spaces (e.g., sports fields, marching band practice areas, the urban farm, and informal outdoor spaces for teaching classes).

THEREFORE: Preserve the open, sunny spaces required for outdoor classrooms. Always consider the use of the open space when selecting and placing trees. This may mean that it is not always possible to replant the total lost tree canopy caused by development projects.

Path Shape

Pathways should be inviting enough to be more than a means of travel. Generally, pathways connect large open spaces or heavily used destinations on the campus. Many of them are former city streets around which the campus has grown or are alongside and parallel to former streets.

THEREFORE: Make pathways places to linger rather than just connectors to pass through by creating wide spots for benches and low walls for seating. Remake old city streets into pathways that emphasize their pedestrian nature and de-emphasize their former car nature.

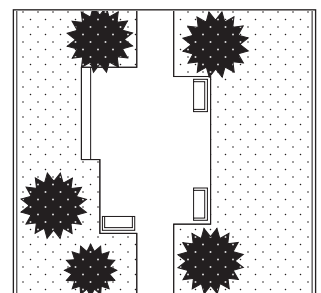
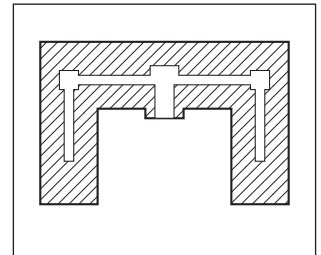
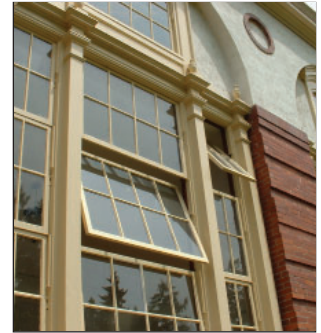

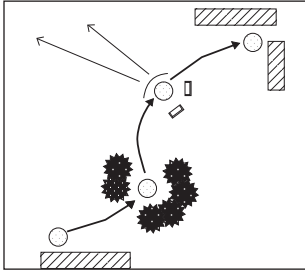

Paths and Goals

The layout of paths will seem right and comfortable only when it is compatible with walking (and walking is far more subtle than one might imagine).

THEREFORE: To lay out paths, first place goals at natural points of interest. Then connect the goals to one another to form the paths. The paths may be straight or gently curving between goals; their paving should swell around the goal.



Pedestrian Pathways* [See “Pathways” in “Principle 2: Open-space Framework” on page 38 for requirements.]

Pedestrian travel should be encouraged as an essential component of the campus experience. Pedestrian activity creates an environment that encourages interaction and discourages automobile use.

THEREFORE: Promote walking by creating a system of interconnected pathways as an alternative to street sidewalks. This pathway system will be considered part of the campus open-space framework.

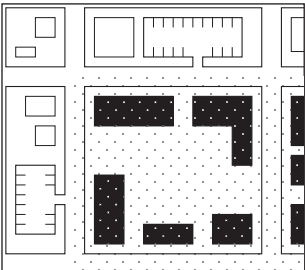

Peripheral Parking

As the university grows, parking may threaten to overwhelm the campus environment. But if parking areas are too far away, teaching and learning may suffer.

THEREFORE: Distribute parking along the edges of the campus (see “Local Transport Area” pattern) so that people can walk from their cars to their destinations in a reasonable amount of time without having to cross the width of the entire campus.

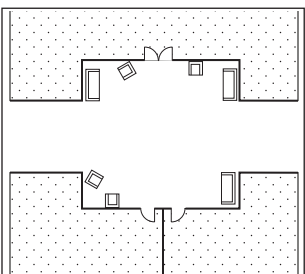

Places to Wait

Students often have to wait outside an office for an appointment or outside a classroom when the preceding class gets out late. Also, after class students and teachers often wish to continue conversations begun in class, but they have no place to do so.

THEREFORE: Provide generous circulation space near classroom entrances and offices, with benches or other seating, but not so much as to attract large groups that might make excessive noise.

Pools of Light

Uniform illumination—the conventional lighting solution—serves no useful purpose whatsoever. In fact, it destroys the social nature of space and makes people feel disoriented and unbounded.

THEREFORE: Place lights to form individual pools of light, which encompass chairs and tables like bubbles, to reinforce the social character of the spaces they form. Remember that you can’t have pools of light without the darker places in between.

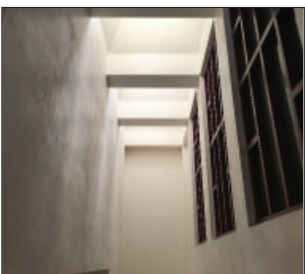

Positive Outdoor Space

In general, outdoor spaces that are merely “left over” between buildings will not be used.

THEREFORE: Always place buildings so that they embrace the outdoor spaces they form. Design the landscape so that some sides of the outdoor space are defined by buildings and some sides by arcades, trees, or low walls. Be sure to leave entrances to the outdoor “room” at several points so people can pass freely through the space and travel to other connecting outdoor spaces.

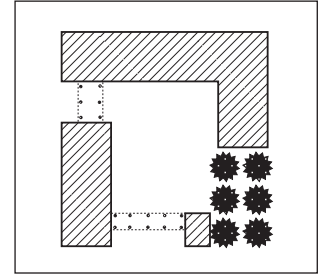

Promenade

Each subculture needs a center for its public life, a place where people can go to see others and to be seen.

THEREFORE: Encourage the formation of promenades through the heart of the campus, linking main activity nodes and placed centrally so that each point in the campus is within ten minutes’ walk of a promenade.



Public Gradient

Unless the spaces in a building are arranged in a sequence that corresponds to their degree of privateness, the visits made by strangers or guests may be a little awkward.

THEREFORE: Lay out the spaces in a building to create a sequence that begins with the most public parts of the building near the entrance, then leads into the slightly more private areas, and finally leads to the most private domains.

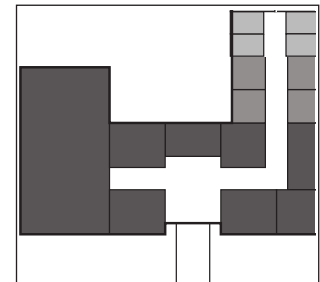

Public Outdoor Room

Only a very few spots exist along the streets of modern towns and neighborhoods where people can hang out comfortably for hours at a time.

THEREFORE: On the campus, make a piece of the common land into an outdoor room—a partly enclosed place, without walls, but with some roof, columns, places to sit, and perhaps with a trellis. Place it beside an important path and within view of many buildings. The Heart of Campus kiosk is an example of a Public Outdoor Room.



Quadrangles and the Historic Core

College campuses are unusual in that their buildings form coherent larger outdoor spaces. Each building is complete in itself, yet the walls form large public open spaces punctuated by the building entrances that open onto them and by cross axes that flow through them, connecting them to other open spaces. These rectilinear, axial open spaces such as malls and quadrangles are the basic framework of the University of Oregon’s historic campus core, which is a part of the campus’s larger open-space framework. Without a specific effort to preserve them, these components of the open-space framework may be diminished or lost because building projects fail to consider them beyond the bounds of the project.

THEREFORE: When building in the historic campus core, create buildings or additions that support and enhance the existing open-space framework of quadrangles and axes.



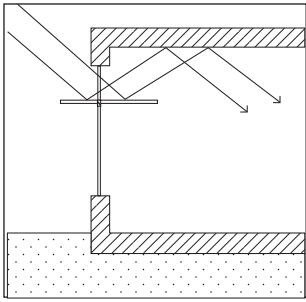

Quality of Light

Daylight, the use of which results in energy savings, is an important aspect to wellness and psychological comfort for building users; it is also beneficial to many of the tasks performed by building occupants. However, glare from daylighting may cause eye strain for employees who use computer monitors.

THEREFORE: Provide ample opportunities for daylight throughout the building in both private and public areas. When possible and appropriate, opportunities to bring natural light into areas further from the perimeter of the building such as clerestory windows, interior windows, or windowed doors should be considered. Provide appropriate shading and defusing devices and furniture arrangement to eliminate glare on computer screens.

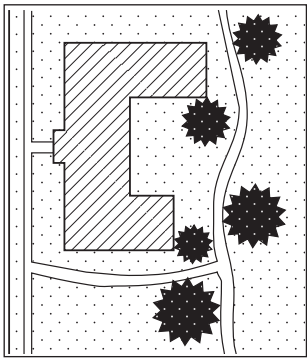

Quiet Backs

Anyone who has to work in noise or in offices with people all around needs to be able to pause and refresh with quiet in a more natural situation.

THEREFORE: Give buildings in the busy parts of campus a quiet “back” behind them and away from the noise. Along this quiet back build a walk that is far enough from the building so that it gets full sunlight but is protected from noise by walls and distance and buildings. Make certain that the path is not a natural shortcut for busy foot traffic, and connect it to other walks to form a long ribbon of quiet alleyways that converge on open spaces.

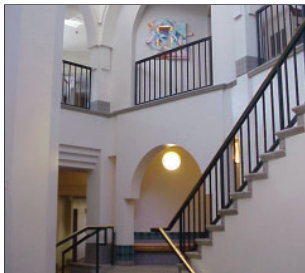

Research Ties

Research areas often need to be connected to each other so that shared equipment can be moved around. Scientists and other researchers need to be near their colleagues so they can share information and ideas.

THEREFORE: Link research domains with covered, level, possibly enclosed, and heated spaces. Use these links between the domains as opportunities for social interaction and support facilities.

Road Crossings

Where paths cross roads, cars have the power to frighten and subdue pedestrians, even when the pedestrians have the legal right-of-way.



THEREFORE: At a point where a pedestrian path crosses a road within the campus (see “Local Transport Area” pattern) make a “knuckle” at the crossing: narrow the road to the width of the through lanes only; use different paving materials to continue the pedestrian path through the crossing and raise it above the roadway; and/or install islands between lanes. Be careful to consider the safety of blind people. Make pedestrian movement more of a priority than car movement.

Seat Spots

Where outdoor seats are set down without regard for view and climate, they will almost certainly be useless.

THEREFORE: Choosing good spots for outdoor seats is far more important than building fancy benches. Indeed, if the spot is right, the most simple kind of seat is perfect. Choose locations facing the sun or in the sun, and look for opportunities where seats can face activities.



Shielded Parking and Service Areas

Parking lots full of cars are inhuman and dead spaces—no one wants to see them or walk by them. Loading docks and service areas also are cluttered and unkempt spaces containing unattractive garbage-filled dumpsters.

THEREFORE: Put all parking lots and service areas behind some kind of screening wall, so that the cars and dumpsters cannot be seen in passing; at the same time take into account the security of the users of these facilities. The surrounding wall may be a building, a low landscape wall, earth berm, or hedge.



Site Repair

Buildings must always be built on those parts of the land that are in the worst condition not the best.

THEREFORE: Never place buildings in the most beautiful places. In fact, do the opposite. Consider the site and its buildings as a single unit. Leave as they are those areas that are the most precious, beautiful, comfortable, and healthy, and build new structures in the least pleasant parts of the site.

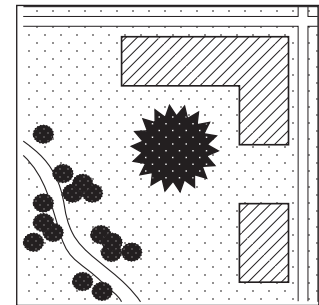

Sitting Wall

In many places low walls are needed to accommodate different landscape levels. Often these are along walkways or at the edges of open areas, which also make great places to sit and rest, think, or watch the world go by.

THEREFORE: Make landscape walls about 17-19 inches high and 12-14 inches wide to accommodate sitting. Do this especially alongside areas of activities to give people a place to sit and watch or to carry on a conversation begun with a chance meeting. Look for sunny places. Design these walls to discourage skateboarding along their tops.



Small Parking Lots in Campus Core

Vast parking lots wreck the land for people.

THEREFORE: In the core of the campus (see “Local Transport Area” pattern), make parking lots small, for 20-30 cars. If a lot requires more parking, build it up as a collection of these 20-30-car lots, along a spine, each lot bounded and enclosed with a low wall, low hedge, or earth berm. (See “Shielded Parking and Service Areas” pattern.)





Small Public Squares

A campus needs public squares; they are the largest, most public rooms on the campus. But when they are too large, they look and feel deserted.

THEREFORE: Make a public square much smaller than first imagined, usually no more than 45 to 60 feet across, never more than 70 feet across. This applies only to its width in the short direction. Its length can certainly be longer.

South Facing Outdoors

People use open space if it is sunny, and they don't use it if it isn't.

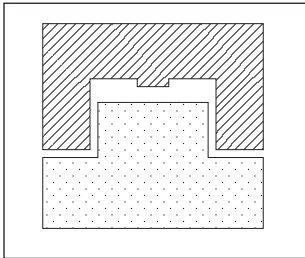

THEREFORE: Place buildings so that the open space intended for use is on the south side of the buildings. Avoid putting open space in the shadow of buildings. And never let a deep strip of shade separate a sunny area from the building it serves.

Spillover Parking

Parking systems adopted for the campus should avoid creating parking problems for surrounding residential neighborhoods.

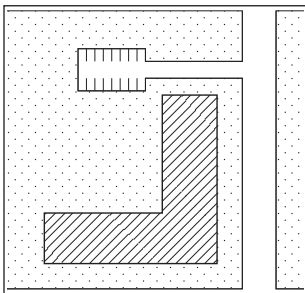

THEREFORE: Provide appropriately placed, adequate off-street parking in conjunction with any new institutional use that creates demand for parking that cannot be met by current parking supplies. Take steps to gain better use of existing off-street parking areas, and work with the City of Eugene to discourage long-term storage of vehicles on the residential streets surrounding the campus. (See “Principle 9: Transportation” on page 81.)

Student Housing

When students live too far from campus, it is more difficult for them to be part of university life. Aside from the educational benefits to students of living on campus, on-campus housing contributes to the vitality and quality of campus life and a sense of community. Undergraduate students especially gain the primary academic benefit of on-campus housing.



THEREFORE: Recognize the value of proximity when locating student housing, in particular housing for entering undergraduate students. Design and locate undergraduate on-campus residence hall housing for entering students so that it supports the goal of integrating the academic life with the residential experience. Also ensure access to food service for residence hall students. Establish a balance between dense housing, which is generally more affordable, and livability.

Sustainable Development* [See “Principle 10: Sustainable Development” on page 85 for requirements.]

Today’s development, repair, maintenance, and operations of the University of Oregon have an impact on the local environment and the ability of future generations to thrive. The physical environment of the university—its landscape and buildings—must also support and enhance the excellence of our academic programs.

THEREFORE: Develop, redevelop, and remodel in ways that incorporate sustainable design principles.

Tree Places

When trees are planted or pruned without regard for the special places they create, they are as good as dead for the people who need them.

THEREFORE: Plant trees according to their nature, to form enclosures, avenues, squares, groves; plant single-spreading trees toward the middle of open spaces. Shape the nearby buildings in response to trees, so that the trees themselves and the trees and buildings together form places people can use. (See the *Campus Tree Plan*.)

Universal Access* [See “Principle 8: Universal Access” on page 77 for requirements.]

In addition to complying with applicable federal and state requirements, the university is committed to making all new facilities welcoming and accessible for all users without discriminating on the basis of ability. This inclusive environment enables all users to participate equally in the university’s programs, activities, and services.

THEREFORE: Design improvements to the campus in ways which ensure welcoming, graceful access for all members of its community.

University Shape and Diameter* [See “Principle 4: Space Use and Organization” on page 55 for requirements.]

When a university is too spread out, people cannot make use of all it offers. On the other hand, a campus diameter based strictly on the ten-minute class break is needlessly restrictive.

THEREFORE: Plan all classes, evenly distributed, within a circle that can be crossed within a seven-minute walk. Place non-class activities such as housing, research offices, and administration outside this circle.

Use Wisely What We Have

New construction reduces limited land inventories and valuable natural resources on and off campus. Development projects also may put pressure on green open spaces, landscape features, and historic resources that contribute to the university’s cultural character and stimulating intellectual environment.

THEREFORE: All new campus growth should promote efficient development and, whenever beneficial, make use of existing facilities to preserve valuable open space and historic resources.

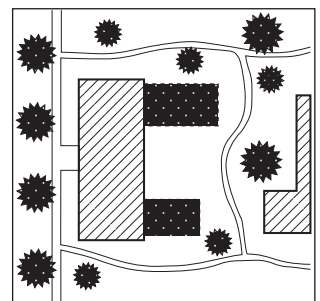
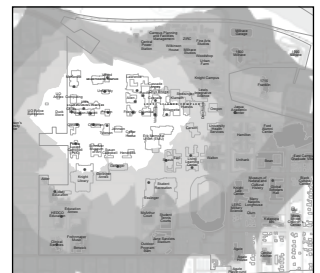
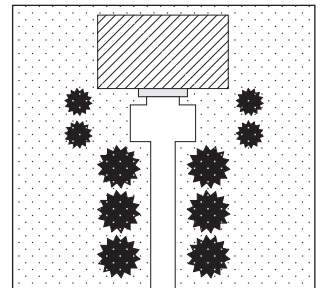
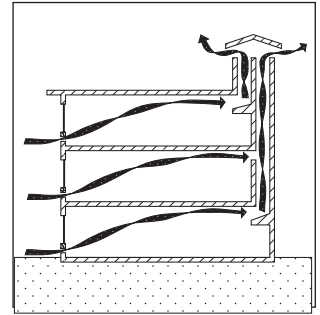

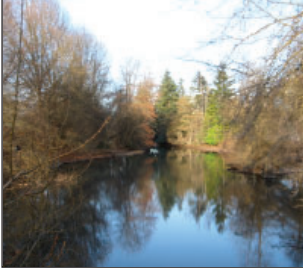

Water Quality

Water quality is directly affected by the manner in which developed lands treat rainwater. The water quality in rivers is enhanced if rainwater is cleaned (by removing car oils and other impurities) or dispersed slowly on a developed site before it enters the city's engineered storm-water systems.

THEREFORE: Provide opportunities for rainwater to be cleaned and dispersed on the development site. Consider green roofs or bioswales when designing, but be mindful of the groomed nature of the campus and its accompanying maintenance requirements.



Welcoming to All

Built environments in which the greatest range of diverse people feel welcome and comfortable promote learning opportunities and encourage an open exchange of ideas.

THEREFORE: Create a campus that addresses the issues of diversity and equity in the built environment, for example, in landscapes, building layout, design details, and artwork.

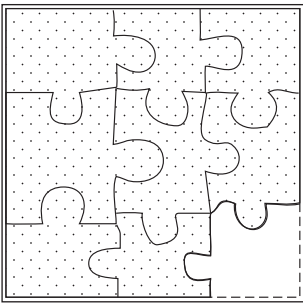

Wholeness of Project

Funding limitations often lead user groups or designers to create phased projects (in the hope of obtaining more funding for later phases) or to use the funds to create more new space without solving the existing facility's problems. These approaches can result in a complicated facility with functional problems, an awkward feel, and a lack of wholeness and integrity.

THEREFORE: Approach the project as a single-phased whole, creating a usable facility with options for future development. Address existing building problems directly, for example through renovations, rather than assuming they will be solved simply by adding new space. This approach may result in compromises, but it gives project users confidence that the built project will suit their needs.

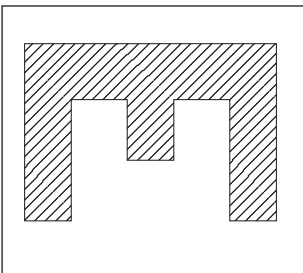

Wings of Light

Buildings are often shaped without concern for natural light and depend almost entirely on artificial light. Buildings that do not allow natural light as a source of illumination are not comfortable places to spend the entire day.

THEREFORE: Shape buildings in ways that allow natural light to penetrate far into their centers. Use ideas like light shelves to bounce daylight even further into the building's spaces. Usually this will mean buildings that have wings less than about 50 feet in width.