

CAMPUS PLAN

2022 EDITION

*Universities are
extraordinary
places.*

2022 EDITION

UNIVERSITY OF OREGON CAMPUS PLANNING

1276 University of Oregon
Eugene, Oregon 97403-1276
<http://cpfm.uoregon.edu>

Christine Taylor Thompson Director, Campus Planning
Elizabeth Thorstenson Planning Associate

ACKNOWLEDGMENTS

Dean Livelybrooks Chair, 2021-22 Campus Planning Committee

2022 LEAD STAFF

Emily Eng Senior Planner, Campus Planning
Michael Harwood University Architect and Associate V.P.
Aaron Olsen Landscape Planning Associate
Christine Taylor Thompson Director, Campus Planning
Elizabeth Thorstenson Planning Associate

The *Campus Plan* is available online at <http://cpfm.uoregon.edu>
or at University of Oregon Campus Planning.

EO/AA/ADA institution committed to cultural diversity.

Printed on recycled-content paper.

Table of Contents

<u>Introduction to the Campus Plan</u>	3
Vision	4
History of the Campus Plan	5
<u>How to Use the Campus Plan</u>	9
Plan Application.....	9
Principle and Pattern Framework	11
<u>Principles</u>	15
<u>Principle 1: Process and Participation</u>	21
Construction Projects.....	22
Amendments to the Plan.....	30
Land-use Applications and Subject Plans	31
Periodic Plan Review	32
Academic Planning Coordination.....	33
Community Coordination.....	34
Area and Site Diagnosis Studies	34
<u>Principle 2: Open-space Framework</u>	37
Designated Open Spaces	37
Pathways	38
Campus Edges.....	38
The Forms and Character of Designated Open Spaces	42
Open-space Enhancement Requirements.....	44
Landscape	45
<u>Principle 3: Densities</u>	49
<u>Principle 4: Space Use and Organization</u>	55
Space Allocation.....	55
Walking Circles: Instructional Core	56
Flexible and Compatible Use	56
Outdoor Classrooms	58
<u>Principle 5: Replacement of Displaced Uses</u>	61
<u>Principle 6: Maintenance and Building Service</u>	65
Maintenance	65
Building Service.....	66
Campus Utilities and Infrastructure	67
<u>Principle 7: Architectural Style and Historic Preservation</u>	71
Architectural Style.....	71
Historic Preservation	73
<u>Principle 8: Universal Access</u>	77
<u>Principle 9: Transportation</u>	81
Land Use and Transportation.....	81
Community Transportation Coordination	82
<u>Principle 10: Sustainable Development</u>	85
<u>Principle 11: Patterns</u>	91
Application of Patterns in the Design Process: Project Pattern Lists	91
Campus-wide Pattern List: A Pattern Language for the University of Oregon	93
Campus-wide Pattern Descriptions.....	94
<u>Principle 12: Design Area Special Conditions</u>	111
Design Area: Academic Center and Historic Core	112
Design Area: Franklin Triangle.....	123
Design Area: PLC Parking Lot	125
Design Area: Southwest Campus	126
Design Area: Millrace	129

Table of Contents Continued

Design Area: Willamette	137
Design Area: Northeast Campus (Academics, Research, and Support Services)	141
Design Area: Northeast Central Campus (Academics, Student Services, and Housing)	147
Design Area: Southeast Campus (Academics, Athletics, and Recreation).....	155
Design Area: Student Housing	159
Design Area: Athletics, Student Support, and Administration.....	164
Design Area: East Campus	167
Appendices.....	176
A: University of Oregon Mission	178
B: Oregon Experiment Principles.....	179
C: Assumptions.....	180
D: Future “To Do” Items	180
E: Oregon State Requirements.....	181
F: Planning Process to Update the Plan in 2005	181
G: Historic Standards for Rehabilitation	182
H: Historic Resources	182
I: University-owned Properties Outside Campus Boundaries.....	186
J: City of Eugene Related Planning and Transportation Documents	186
K: Summary of All Amendments to the Campus Plan (since 2005)	187
L: Walking Circles - Additional Maps	190

Maps

Map 1: University of Oregon Campus Boundaries	9
Map 2: University-owned Properties	10
Map 3: Designated Open Spaces	39
Map 4: Pathways	41
Map 5: Design Areas	50
Map 6: Walking Circles	57
Campus Walking Circles - Examples	190



HEDCO Courtyard, 2009.

INTRODUCTION TO THE PLAN



13th Avenue Axis and the Memorial Quadrangle as viewed from Lillis, 2009.

INTRODUCTION TO THE CAMPUS PLAN

Universities are extraordinary places. Nowhere else is there such a rich array of activities, all focused on creating a stimulating learning environment. An integral component of such an environment is the physical design of a university's campus – its buildings and open spaces.

The University of Oregon has a long and proud heritage of shared governance by faculty, staff, and students, all of whom have a role in creating the university's unique learning environment. A shared vision ensures that every change, big or small, will lead the university toward a unified and successful campus design. **The Campus Plan (the “Plan”) guides this shared vision by providing the principles and patterns that define the type and extent of future campus development.**

The university recognizes the need to respond quickly to emerging opportunities for facilities improvements, but also emphasizes long-range planning and the importance of maintaining continuity in development decisions over time. The Plan is based on a ten-year outlook, but its vision, patterns, and principles are useful for longer-term projections.



“The outward aspect of the physical plant of a university should exemplify the teaching of that university – in good taste, beauty and efficiency.”

-Ellis F. Lawrence, Campus Planner and Founder of the School of Architecture and Allied Arts and Dean, 1914-1946.



“New construction and beautification bring a tangible and exciting sense of renewal to a campus that is already both functional and visually stunning.”

- David Frohnmayer, University of Oregon President, 1994-2009.

Vision

The University of Oregon's campus will be responsive to the needs of its occupants, adaptable to emerging opportunities, and beautiful to behold.



Lawrence Courtyard, c.1940.



University Health and Counseling Center User Group, 2004.

Responsive to the Needs of the Institution and its Occupants

University of Oregon facilities will support the institution's missions in teaching, research, and service to the state. Campus facilities exist solely to aid in achieving this mission. (Refer to UO mission in Appendix A.)

The university will continue to improve opportunities for broadly-based participation in facilities planning. Planning decisions, however, will be based primarily on overall institutional objectives and secondarily on departmental or non-institutional concerns.

Ready to Adapt to Changing Opportunities

The Plan's premise is that the plan for the campus is a process rather than a fixed-image map. This unique concept evolved out of a 1974 project known as "The Oregon Experiment" (which is the subject of a book with the same title).

Restrictions inherent in a fixed-image campus plan make it difficult to respond to unpredictable changes. Instead, the university's planning decisions are guided by a process that engages users and is informed by a principle framework that preserves and enhances the essence of the campus as it is described below.

The university reaffirms the six basic principles articulated in The Oregon Experiment as the underlying premises of this Plan (listed in the side bar and defined in Appendix B).

The Oregon Experiment's Six Basic Principles:

- 1. Organic Order:** Campus design emerges through a process, not from a map.
- 2. Incremental Growth:** Development occurs in large and small pieces.
- 3. Patterns:** Shared design statements guide the planning process.
- 4. Diagnosis:** Assessing existing conditions informs ongoing improvements.
- 5. Participation:** User involvement must prevail throughout the planning process.
- 6. Coordination:** Working together benefits the campus as a whole.

Beautiful to Behold

The fundamental character of the University of Oregon's campus is represented by a series of large open spaces, a mature landscape, and the accompanying buildings conceived and executed by Ellis F. Lawrence in the early part of the last century. The concepts Lawrence employed include high-quality, humanly scaled, carefully detailed buildings arranged around a system of open spaces interconnected by pathways. These concepts are the basis for further campus development.



Willamette Hall, 2005.

Why Do We Do Campus Planning?

To remain vital, the University of Oregon needs facilities that effectively support its three-part mission of exceptional teaching, discovery, and public service. The campus itself is a strong recruitment tool for faculty and staff. Among other considerations, students make their decisions about which college to attend based on the “look and feel of the campus.” Also, avoiding past mistakes contributes to the retention of the best qualities of our campus. Without careful stewardship, the University of Oregon could lose its open spaces—one of our most distinguishing features—to new construction.

History of the Campus Plan

This document contains a framework of principles intended to guide development of properties owned by the University of Oregon that are either within or outside of the Campus Boundaries. It is the most recent in a series of documents that began with Ellis Lawrence's preparation of a “Block Plan” of the campus in 1914. Lawrence revised his initial effort in 1923 and prepared a major modification in 1932.¹

The concepts of spatial organization contained in these early plans were reflective of Lawrence's Beaux-Arts training and are still evident on this campus today. The principles expressed in this current document preserve and expand the network of interconnected quadrangles, squares, malls, and promenades, which were characteristic of Lawrence's early development pattern.



Gerlinger Hall, garden wall, 2013.

In 1962, the university selected urban designer Lawrence Lackey to prepare a new campus plan. That plan was a fixed-image map showing the future location of new buildings.² It provided some guidance for campus

¹ Michael Shellenbarger, “Ellis F. Lawrence: Nonresidential Designs,” *Harmony in Diversity: The Architecture and Teaching of Ellis F. Lawrence*, ed. Michael Shellenbarger (Eugene: University of Oregon, 1989), pp. 48-50.

² Lawrence Lackey, *University of Oregon Campus Planning Studies Progress Report 3* (July 1962).

development, including the placement of Bean Hall, Oregon Hall, some science facilities, and an addition to Knight Library. Two major campus structures built in the late 1960s, the University Health and Counseling Center and the former law center, were not contemplated by the plan, and one of its main features – the development of academic buildings on the Pioneer Memorial Cemetery site – was never implemented.

By 1973, the need for a new plan was acknowledged, and the Center for Environmental Structure, headed by Christopher Alexander, was retained for that purpose. The result of this collaboration between the Center for Environmental Structure and the university was The Oregon Experiment.³ Instead of creating a static fixed-image master plan The Oregon Experiment established a process by which development decisions could be made on an ongoing basis. This concept acknowledges the fact that the exact nature and magnitude of future changes cannot be predicted with any degree of certainty, and that object-oriented plans based on explicit assumptions about the future become outdated as the “future” becomes known.

The 1991 Long Range Campus Development Plan represented a continuation of these planning traditions. A large body of norms, traditions, and development principles had developed over the course of the institution’s history, but had remained unwritten or at best recorded only in repetitive actions of individuals and groups engaged in campus development activities.



East Campus Green, 2005.

The intent of the 1991 Plan was to unify in a systematic way those norms, traditions, and principles with the essential elements of the Lawrence ideal and the fundamental principles of The Oregon Experiment. The East Campus Green, shown below, was created in 1990 and is an example of the continued preservation and extension of Lawrence’s open-space framework.

The 2005 Plan replaces the 1991 Long Range Campus Development Plan. While the 2005 Plan modifies and refines portions of the 1991 Plan, the essence of the original document, which has served the campus well over the years, is preserved. (Refer to Appendix F for a description of the update process.)

The 2005 Plan was judged by the City of Eugene to be in compliance with the Metropolitan Area General Plan. In addition, the Plan complies with the requirements of relevant Oregon Administrative Rules and Statutes. (Refer to Appendix E.)

In 2011, the university adopted a policy entitled “Campus Planning” as part of a campus-wide effort to formalize all university policies. The new policy points to the Campus Plan for a description of the university’s requirements with respect to physical development of university properties. (Refer to the university’s Policy Library.)

In 2012, the Riverfront Research Park Conditional Use Permit expired along with the separate design process for this area. In 2018, a new Conditional Use Permit was approved by the City of Eugene. and in 2021, *Campus Plan* amendments fully integrated this area into the plan.

In 2016, the Campus Physical Framework Vision Project was completed. This further provides greater specificity to the *Campus Plan* and is being used to inform further amendments to the *Campus Plan*

Plan amendments are described in Appendix K.

³ Christopher Alexander et al., *The Oregon Experiment* (New York: Oxford UP, 1975).

HOW TO USE THE CAMPUS PLAN



Outside of Johnson Hall, 2013.

HOW TO USE THE CAMPUS PLAN

Plan Application

The *Campus Plan* is a University of Oregon document that defines the type and extent of campus development. It is a framework of patterns and principles that describe the university's requirements with respect to the physical development of university properties.

This Plan applies to:

1. University-owned Properties Within the Contiguous Approved Campus Boundaries

This Plan applies to university-owned properties within the contiguous Campus Boundaries as shown on Map 1, with the exception of properties that are ground-leased to an outside entity. Properties that are ground-leased shall comply with all lease requirements.

2. University-owned Properties Outside of the Campus Boundaries

This Plan also applies to university-owned properties outside of the Campus Boundaries. However, university review and approval of changes to these properties shall be as defined by the president following recommendations by the Campus Planning Committee and may include some or all of the principles within this document.

Refer to “Principle 1: Process and Participation” (page 21) for how this determination will be made. See Map 2 on the following page. Also, see Appendix I for a list of university-owned properties outside of the Approved Campus Boundaries.

3. University-controlled Properties

Properties that are fully leased and occupied by the University (e.g. properties leased from the UO Foundation) are subject to *Campus Plan* requirements to the degree applicable and in a manner similar to University-owned properties outside of the Campus Boundaries.



Map 1: University of Oregon Campus Boundary



Map 2: University-owned Properties + University Leased Properties in Vicinity of Campus
 (Refer to Appendix I for a list of university-owned properties outside the campus boundaries, page 184.)

- Leased
 - Owned

Principle and Pattern Framework

Below is a description of the organization of the Plan and the key terms used throughout.

The next chapter, “Principles,” summarizes the twelve Campus Plan principles. It is followed by the twelve principle chapters, each of which sets forth principle refinements and patterns related to a specific principle.

The Plan is organized as follows:

CAMPUS PLAN PRINCIPLES

Principles are adopted methods that describe how to apply the Plan’s vision. They are expressions of the university’s requirements with respect to the physical development of university properties. Examples of principles are “Principle 5: Replacement of Displaced Uses” and “Principle 8: Universal Access.” Principles apply to all development projects, as described in “Principle 1: Process and Participation” on page 21.

PRINCIPLE REFINEMENTS

Principle refinements provide greater definition to each principle. They apply to all development projects, as described in “Principle 1: Process and Participation” on page 21. For example the principle refinements for the “Universal Access” principle describe specific design modifications to achieve maximum accessibility in new and remodeled facilities.

PATTERNS

Patterns are design statements that describe and analyze how design issues might be resolved. In addition to the patterns that are included in the Plan, new patterns addressing specific issues will be developed during the planning phase of individual projects. (See “Principle 11: Patterns” on page 91)

DESIGN AREA SPECIAL CONDITIONS

For the purposes of the Plan, the campus is divided into Design Areas, each of which has a distinct feel and history. Examples are “Academic Center and Historic Core” and

“Academic, Research, and Support Services.” “Principle 12: Design Area Special Conditions” (page 111) defines the special conditions to be considered as development occurs within a Design Area.

The following separate documents supplement the Plan:

SUBJECT PLANS

Subject Plans are created to address specific subjects or areas in greater detail. They are considered principle refinements. When adopted, they become part of the Plan, but they are contained in separate documents and do not require a public hearing process to adopt or amend. The *Campus Tree Plan*, and the *Development Policy for the East Campus Area* are examples. (Refer to the diagram on the next page for a complete list.)

PROJECT SCHEMATIC DESIGNS AND SITING PLANS

Project schematic designs and siting plans are developed for construction projects. All are considered principle refinements. When adopted, they become part of the Plan, but they are contained in separate documents and do not require a public hearing process to adopt or amend.

STANDARDS

Standards describe in greater detail than principle refinements how to apply Plan patterns and principles, in particular as related to the design of utilities, building systems, landscape materials and furnishings, exterior lighting, building finishes, maintenance, and service needs. They are not considered part of the Plan and are contained in separate documents. The *Campus Construction Standards* are an example.

OTHER UO DOCUMENTS AND STUDIES

Other UO documents and studies (e.g., Planning Procedure Guide, diagnosis studies, conceptual studies, and historic surveys) provide useful information.

Diagram of Campus Planning Documents

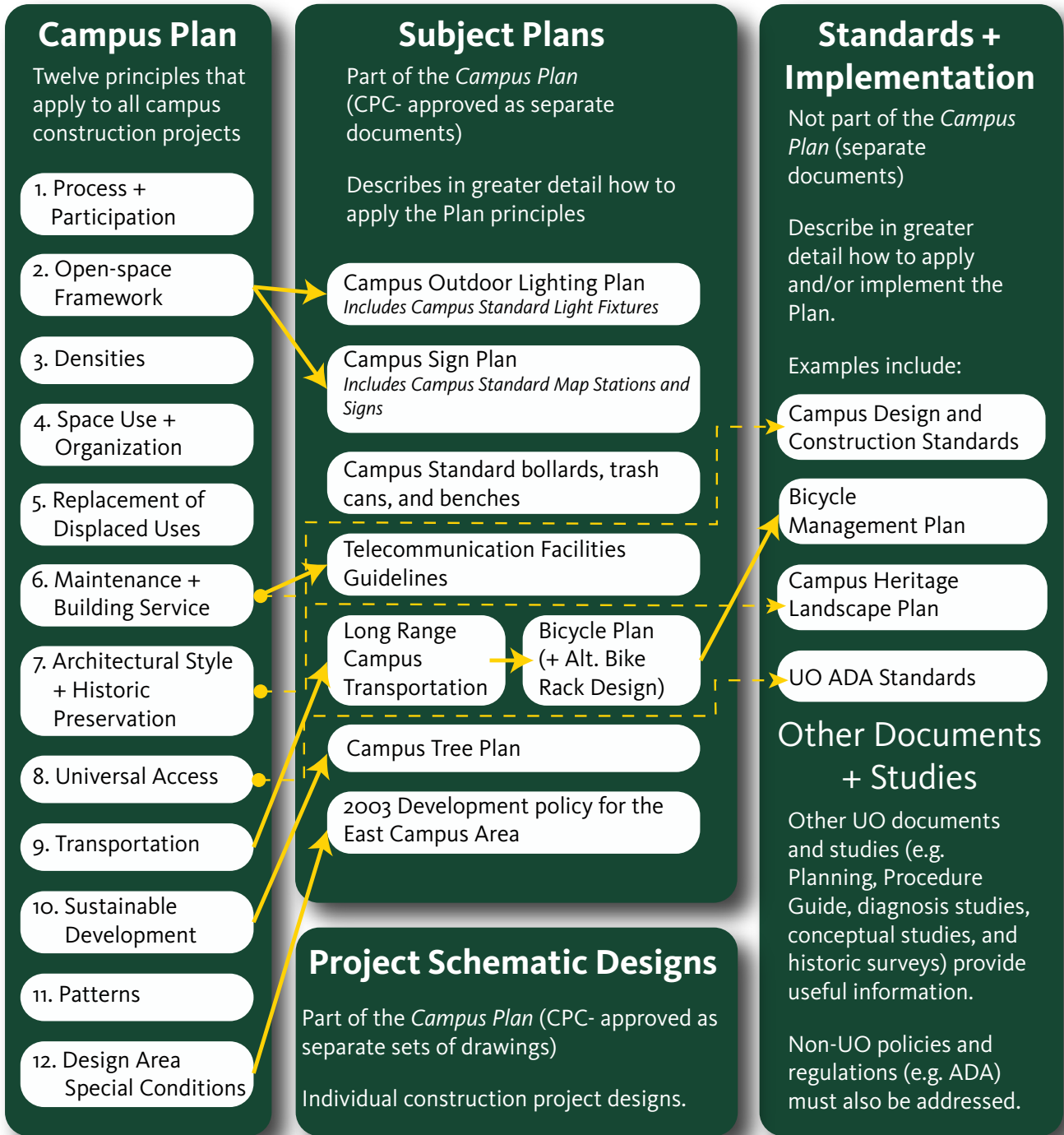

The *Campus Plan* and all subject plans are available at the Campus Planning Office (*Campus Planning and Facilities Management office* or online at cpfm.uoregon.edu/campus-planning)

PRINCIPLES



Jordan Schnitzer Museum of Art

PRINCIPLES

Campus Plan principles are adopted methods that describe how to apply the *Campus Plan* to development projects. They are expressions of the university's requirements with respect to the physical development of university properties. Principles apply to all development within the Plan's jurisdiction.

Each principle below is further elaborated in a later chapter of the Plan.

PRINCIPLE 1: PROCESS AND PARTICIPATION



The structured and effective manner in which the university's planning process functions stems from the principles described in *The Oregon Experiment*. The cornerstone of the process is the principle of participation, which is an extension of an established tradition in Oregon generally and at the University of Oregon in particular.

Three other principles – organic order, coordination, and diagnosis – also are relevant to Principle 1 and ensure responsiveness to the institution's needs. (Refer to page 19.)

To implement these principles from *The Oregon Experiment*, the university shall follow the planning process principle refinements in “Principle 1: Process and Participation” (page 21) for all construction projects and campus planning activities.

PRINCIPLE 2: OPEN-SPACE FRAMEWORK



The University of Oregon campus is organized as a system of quadrangles, malls, pathways, and other open spaces and their landscapes. This organizational framework not only functions well, but also serves as a physical representation of the university's heritage.

As opportunities arise, the fundamental and historic concepts of the university's open-space framework and its landscape shall be preserved, completed, and extended. All construction projects shall follow the principle refinements established in “Principle 2: Open-space Framework” (page 37).

PRINCIPLE 3: DENSITIES



Development densities are established to preserve the historic character of the university campus as a setting conducive to thoughtful and reflective endeavor, while at the same time allowing for accommodation of new facilities.

To control the look and feel of the campus, no construction project shall result in a density in excess of the maximum densities established in “Principle 3: Densities” (page 49).

PRINCIPLE 4: SPACE USE AND ORGANIZATION



When a university is too spread out, people cannot make use of all it offers. On the other hand, a campus diameter based strictly on the ten-minute class break is needlessly restrictive. The location of program spaces greatly affects how the campus functions and influences the degree of positive interaction.

In order to distribute the campus's available space in ways that are functional, flexible, and compatible, all proposed projects and space assignments shall meet the principle refinements as described in "Principle 4: Space Use and Organization" (page 55).

PRINCIPLE 5: REPLACEMENT OF DISPLACED USES



All university uses are important to the university. A new use must not benefit at the expense of an existing use.

All plans for new construction (buildings or remodeling projects) shall keep existing uses intact by developing and funding plans for their replacement as described in "Principle 5: Replacement of Displaced Uses" (page 61).

PRINCIPLE 6: MAINTENANCE AND BUILDING SERVICE



The university was established over 135 years ago and is likely to continue far into the future. Its continued viability depends on the creation of a campus that is long lasting, easily maintained, and easily serviced.

The university's campus and facilities shall be designed to meet long-term university needs and to be efficiently maintained and operated in accordance with the principle refinements in "Principle 6: Maintenance and Building Service" (page 65).

PRINCIPLE 7: ARCHITECTURAL STYLE AND HISTORIC PRESERVATION



The continuity and quality of the university's campus environment are materially affected by the character and architectural style of the buildings. Furthermore, the university's historic buildings and landscapes, which are important defining features of the campus, are artifacts of the cultural heritage of the community, the state, and the nation.

To preserve the overall visual continuity and quality of the campus and as a commitment to the preservation and rehabilitation of identified historic resources, all construction projects shall follow the principle refinements in "Principle 7: Architectural Style and Historic Preservation" (page 71).

PRINCIPLE 8: UNIVERSAL ACCESS



In addition to complying with applicable federal and state requirements, the university is committed to making all new facilities welcoming and accessible to all users without discriminating on the basis of ability. This inclusive environment enables all users to participate equally in the university's programs, activities, and services.

To provide access for all of members of its community, all construction projects shall follow the principle refinements set forth in “Principle 8: Universal Access” (page 77).

PRINCIPLE 9: TRANSPORTATION



Carefully addressing transportation needs is vital to creating a cohesive, functional campus. A complete transportation principle includes coordinating transportation efforts with the larger community.

To ensure the safe, efficient, and affordable transportation needs of the campus community, all construction projects shall follow the principle refinements in “Principle 9: Transportation” (page 81).

PRINCIPLE 10: SUSTAINABLE DEVELOPMENT



The development, repair, maintenance, and operations of the University of Oregon today have an impact on the local environment and the ability of future generations to thrive.

All development, redevelopment, and remodeling on the University of Oregon campus shall incorporate sustainable design principles including existing and future land use, landscaping, building, and transportation plans as described in “Principle 10: Sustainable Development” (page 85).

PRINCIPLE 11: PATTERNS

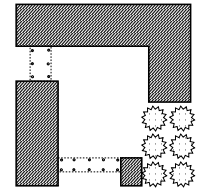

Patterns establish a means of articulating commonly held values as they pertain to the campus environment and design. Patterns ideally function together as words in a sentence, creating a cohesive whole built on a common design language, the “pattern language.”

To achieve effective and meaningful dialog about important campus design issues, all construction projects shall consider the patterns contained in “Principle 11: Patterns” (page 91).

PRINCIPLE 12: DESIGN AREA SPECIAL CONDITIONS



The campus is composed of approximately 295 acres. Within this vast area smaller areas of campus exist, each with its own distinct feel and history. High-quality development requires attention to the unique details that give each of these individual Design Areas its own character.

To ensure that the unique characteristics of specific areas are not overlooked, all proposed construction projects shall consider the special conditions in “Principle 12: Design Area Special Conditions” (page 111).

PRINCIPLE 1



PROCESS AND PARTICIPATION

PRINCIPLE 1: PROCESS AND PARTICIPATION



Principle

The structured and effective manner in which the university's planning process functions stems from the principles described in *The Oregon Experiment*. The cornerstone of the process is the principle of participation, which is an extension of an established tradition in Oregon generally and at the University of Oregon in particular.

Three of the other principles also are especially relevant to "Process and Participation" and ensure responsiveness to the needs of the institution:

ORGANIC ORDER – The whole emerges gradually from separate actions, and the welding of these actions into a cohesive whole comes not from a predetermined map, but from the application of a process.

COORDINATION – The institution has interests that must be accounted for, and coordination of separate development activities is essential if they are to result in a cohesive campus.

DIAGNOSIS – Periodic analysis, or diagnosis, of the present state of the campus is required in order to provide a general context to direct continuous repair and improvement.

To implement these principles from *The Oregon Experiment*, the university shall follow the planning process principle refinements for all construction projects and campus planning activities.

Principle Refinements

All construction projects and campus planning activities shall follow the processes described in this section.

Construction Projects – page 22

Amendments to the Plan - page 30

Land-use Applications/Subject Plans – page 31

Periodic Plan Review – page 32

Academic Planning Coordination - page 33

Community Coordination – page 34

Area and Site Diagnoses – page 34

The university's physical environment—its buildings and open spaces—is intended to support the university's mission. All processes that are part of this Plan, including adoption, amendment, refinement, and amplification of patterns and principles, acknowledge this relationship.

The university's planning process is the heart of this Plan. It is designed to ensure that

- meaningful opportunities exist for participation in the planning and design process,
- decisions are based upon a principle framework that preserves and enhances the essence of the campus as described in this Plan, and
- planning decisions are coordinated and based upon overall institutional objectives.

Construction Projects

The following shall apply to all capital construction, capital improvement, and capital repair projects covered by the Plan.

This section covers three distinct types of construction projects (summarized in the flow chart on page 25):

Track A - Minor Exterior Alterations and Proposals to Demolish or Move a Structure, page 26.

Track B - Additions/Major Alterations & New Stand-alone Buildings, page 27.

Track C - Privately Controlled On-campus Construction Projects & Off-campus Construction Projects on UO-owned Land, page 29.

Notes: For repair, remodel, and interior projects that do not fit into one of the tracks above, see note on page 24.

For conceptual plans and feasibility studies, see note on page 24.

Participants

Several entities, each with specific roles and responsibilities, are involved in planning for these types of construction projects. Key participants include:

- Project Sponsor
- Campus Planning Committee
- User Groups
- Campus Planning and Facilities Management

Introduction: Construction projects emerge from a series of planning steps with the assistance of Campus Planning and Facilities Management:

1. Project Formulated – Departments and offices formulate building project ideas. Often

this includes preparation of early planning studies (e.g., programming and conceptual studies) to determine the project size. See note about conceptual studies on **page 24**.

2. Prioritized – The university compiles a Capital Construction Budget Request every two years to identify major capital projects that may move forward for state approval. The *Biennial Capacity Plan* is prepared to make sure there is room on campus for proposed expansions. Both of these documents are reviewed by the Campus Planning Committee (refer to the Academic Planning Coordination section of this chapter on **page 33**).

3. Authorized – The university is authorized to pursue the project.

4. Funded – The university secures full funding for the project.

5. Schematic Design & Construction Documents Completed

– Once a project is fully funded (or, at the direction of the vice president responsible for the project, if less than full funding is in hand), the Director of Campus Planning will determine applicability to the Plan and will clarify the appropriate planning process based on the size, location (for example, on or off campus), and funding source of the proposed project.

A site is selected and the schematic design is completed, both of which are reviewed by the Campus Planning Committee. Refer to the “Planning Process Flow Chart” on **page 25** for more information.

6. Constructed – The approved project is constructed.

Project Sponsor: This is typically a dean or department head but always the primary administrator of the unit (or designee) responsible for the project. The role of the project sponsor is to define the project and program, secure funding, and help establish the user group.

Campus Planning Committee: The Campus Planning Committee is responsible for implementing the principle of coordination first identified in *The Oregon Experiment*. It is responsible for establishing procedures for the review of construction projects, plan amendments, and other planning actions covered in this chapter. The Campus Planning Committee chair appoints user groups. (See description of user group on **page 24**.)

The Campus Planning Committee is a large group of faculty, staff, and students representing a broad spectrum of the campus community. It is responsible for ensuring that all projects are consistent with the larger campus setting as defined in this Plan. Designs for construction projects and Subject Plans are considered refinements of principles and must be consistent with them. As a general rule the Campus Planning Committee is responsible for reviewing proposed changes to campus landscapes, exterior building designs, and interior designs of major public spaces for projects that have full funding in place. It is not responsible for formally reviewing and approving conceptual designs of projects not yet funded, feasibility studies, interior designs (except as noted), decorations, or furnishings.

In accordance with the implementing legislation of the Campus Planning Committee, the committee is charged with advising the president on issues related to the development of the campus. Accordingly all actions by the committee will be in the form of recommendations to the president. When proposals and plans are approved by the president, they become part of the Plan, even though they are contained in separate documents.

With the exception of minor projects and demolition or removal of a structure, the committee usually will meet with the project's sponsor at least two times in the process—once to review the process and the site for the project prior to the selection of architectural consultants and once to review the project's design. Additional meetings may be necessary. The project sponsor will work with Director of Campus Planning to determine the appropriate time for Campus Planning Committee review(s).

Meeting notification procedures described in the following sections are intended to allow interested parties an opportunity to review and comment on proposed projects. These provisions are not intended to restrict the delivery of notice to other individuals by other means. Additional notice and opportunity for public comment often are employed. For larger projects, this usually includes campus-wide public comment sessions prior to Campus Planning Committee review.

The record of the Campus Planning Committee meeting at which a recommendation is formulated shall include findings in support of the committee's recommendation. If an approved project is not implemented within three years, the Director of Campus Planning may determine that a follow-up review is required to determine if the proposal is still acceptable.

A Campus Planning Committee recommendation to the president may be appealed by a member of the committee, by the University/Community Liaison Committee (U/CLC) in a manner as provided by the U/CLC bylaws, by a member organization of the U/CLC, or by a recognized neighborhood organization affected by the recommendation. (See "Community Coordination" on **page 34** for information about the U/CLC.)

The appeal must be filed with the Vice President for Finance and Administration (VPFA) within twelve days of the mailing of the recommendation and must state specifically how the Campus Planning Committee failed to properly evaluate the proposed project or make a decision consistent with the Plan. The VP for Finance and Administration shall establish a date and time for a hearing on the issue, conduct the hearing, and develop findings as a basis for ruling on the appeal. The vice president may delegate these responsibilities.

Refer to the Campus Planning Committee charge for a complete description of the CPC's role, membership, and reporting.

User Groups: A user group serves as the client representative throughout a project's design process. Its members are appointed by the chair of the Campus Planning Committee, and it is made up of faculty, staff, and students who use (or will use) the facility, as well as representatives from neighboring buildings, one of the professional design departments or programs (landscape architecture, architecture, or interior architecture), and the Campus Planning Committee. A user group also may include community members and neighborhood representatives. A user group will represent the campus's diverse population to the greatest degree possible. This broad base of representation ensures that the resulting design meets the specific program needs and fits into the larger campus setting as described in this Plan.

The user group is responsible for developing a project description based upon the established project description and program funding. It then works with Campus Planning and Facilities Management to select an architect, landscape architect, or other suitable professional designer and to forward its recommendation to the president. Members of the Campus Planning Committee are invited to join the process of identification, evaluation, and selection of these professionals. The user group works directly with the consultant(s) to prepare a schematic design for Campus Planning Committee review.

Campus Planning and Facilities Management (CPFM):

University Architect & AVP for CPFM and Design Advisory Board (DAB): The DAB is advisory to the University Architect & AVP for CPFM. The purpose of the DAB is to review architectural details and offer recommendations on the building architecture and landscape architecture to the University Architect to improve the project's design.

The DAB process is established and managed by the University Architect who serves as the Board chair and determines which projects are subject to review. Membership is determined by the University Architect but must consist of University of Oregon and non-University of Oregon experts. A project is typically reviewed

a number of times, during schematic design and design development at the discretion of the University Architect.

CPFM Staff: CPFM staff, along with auxiliary facilities managers, coordinate all building and landscape repair and maintenance projects, as well as some interior projects. All such projects must meet applicable Plan principles and patterns whether or not they are subject to Campus Planning Committee review. A determination of applicable Plan principles and patterns shall be made for each project.

For example, interior remodel projects must address principle refinements related to space use (Principle 4), replacing displaced uses (Principle 5), maintenance (Principle 6), historic preservation (Principle 7), universal access (Principle 8), and sustainable development (Principle 10). Patterns addressing building interiors include, among others, Operable Windows, Flexibility and Longevity, and Classroom Distribution.

Landscape maintenance projects must address requirements related to plant materials and landscape features (Principle 2), historic preservation (Principle 7), and sustainable development (Principle 10). Applicable patterns include, among others, Campus Trees, Outdoor Classroom, and Shielded Parking and Service Areas.

A note about Conceptual Plans and Feasibility Studies:

Many projects begin with a conceptual design phase, which, as its title suggests, is conceptual in nature. This phase describes construction or program needs so that funding can be identified.

Such studies usually are conducted without broad campus-wide input (although most include broad input from the expected project users) and do not address campus-wide issues such as those enumerated within this Plan.

A note about Repair, Remodel and Interiors Projects: Refer to CPFM section above.

Construction Projects
Planning Process Flow Chart

PROJECT IS FUNDED

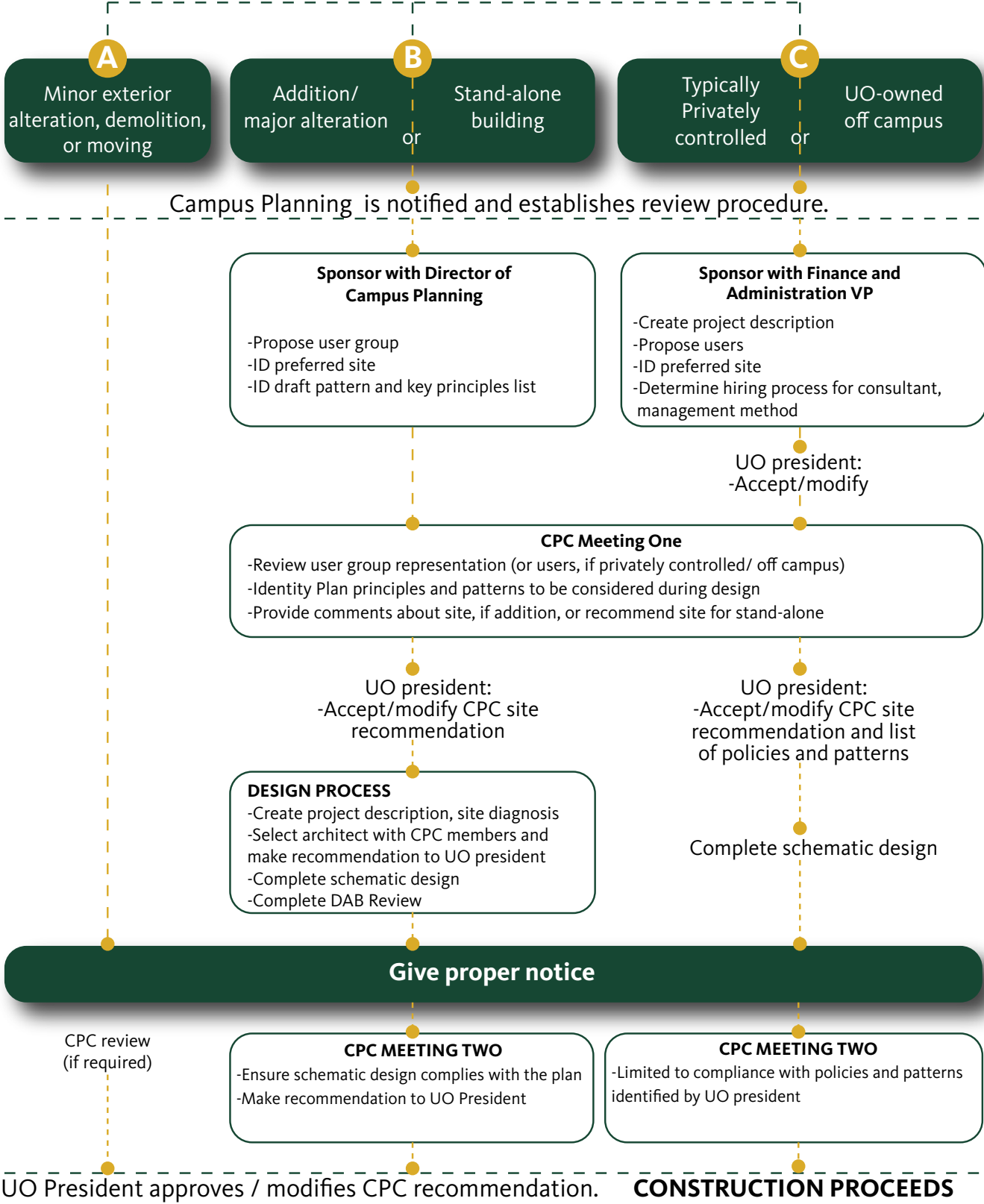

PRINCIPLE 1

A

Minor Alterations and Proposals to Demolish or Move a Structure

The following steps shall apply to funded minor alterations and proposals to demolish or move a structure (including East Campus Area houses and outbuildings, see examples below) within the Campus Boundaries.

STEP 1. Director of Campus Planning

Determination of which projects are considered minor is the responsibility of the Director of Campus Planning, who may consult with the Campus Planning Committee chair.

Each proposal shall be referred to the Director of Campus Planning for analysis of the proposal's consistency with the provisions of the Plan and determination of the process to be followed.

Minor alterations include any noticeable yet minor modifications to building exteriors, outdoor spaces, or interior spaces with significant public exposure. Examples include minor landscape improvements, building awnings, clearly visible HVAC equipment, non-standard signage, and minor additions such as porches. Also included are minor changes to previously approved schematic designs for Track B projects (see next page).

*Examples of projects not subject to Campus Planning Committee review:*⁴

- Standard repair and maintenance projects or minor changes that are not visible to the general public from a designated open space.
- Proposals to move or demolish East Campus houses within the PL Public Land zoned area (with or without the EC East Campus zoning overlay). However, committee review is required for proposals to demolish or move houses within the R-1 Low Density residential zoned areas (for example, along Villard Street between 15th and 19th Avenues).
- Campus standard designs (e.g., benches, handrails, lights, and signs). However, the proposed location of these elements may

require review.

- Alterations within Service Areas as long as they are not a substantial change as viewed from a public area.
- Temporary structures (typically 30 days or less).

STEP 2. Campus Planning Committee

Meeting One

Process and Site Selection

Not applicable.

STEP 3. Design

The design process shall be determined by CPFM in consultation with the project sponsor and others as appropriate. Key *Campus Plan* principles and patterns should be identified during this stage. User groups typically are not assembled for minor projects. However, interested parties should be identified and consulted prior to Campus Planning Committee review (e.g., Facilities Services, directly affected departments, etc.).

This step is not applicable to proposals to demolish or move a structure.

STEP 4. Campus Planning Committee

Meeting Two

Review, Notification, and Recommendation

The Campus Planning Committee shall review all minor projects for conformance with the Plan. This includes proposals to demolish or move a structure, with one exception noted below. Following its review, the committee will make a recommendation to the president. (For a complete description of the Campus Planning Committee, see **page 23**.)

Meeting Notification: All minor projects subject to Campus Planning Committee review shall follow the same notification procedures required for additions/major alterations. (Refer to Track B, step 4, **page 28**.)

⁴ Repair, remodel, maintenance projects (interior, exterior, and landscape), whether or not they are subject to Campus Planning Committee review, must be coordinated through Campus Planning and Facilities Management (see **page 24**) and meet applicable Plan principles and patterns. The Committee for Academic Infrastructure, in consultation with the above-mentioned offices, has primary responsibility for the design of general-pool classrooms. See "Principle 4: Space Use and Organization" on **page 55**.

Appeals: A Campus Planning Committee recommendation to the president may be appealed as described in the “Campus Planning Committee” section on **page 23.**)

B Additions/Major Alterations and New Stand-alone Buildings

The following steps shall apply to funded additions/major alterations and proposals to construct stand-alone buildings within the Campus Boundaries. Major alterations include modifications to outdoor spaces or modifications to interior on-campus spaces with significant public exposure.

STEP 1. Director of Campus Planning

Each proposal shall be referred to the Director of Campus Planning for analysis of the proposal’s consistency with the provisions of the Plan and determination of the process to be followed.

User Group/Draft Pattern and Principle List

The project sponsor shall work with the Director of Campus Planning to create a draft key principle and pattern list (refer to “Principle 11: Patterns” on **page 91**) and identify user group members.

Projects that involve major additions, new construction, or significant modifications to outdoor spaces or interior spaces with significant public exposure are guided by a user group. Members will be appointed by the Campus Planning Committee (CPC) Chair. (For a complete description of user groups, see **page 24.**)

Preferred Site

For stand-alone buildings, the Director of Campus Planning shall establish a site selection process with the Campus Planning Committee (Refer to Step 2).

STEP 2. Campus Planning Committee

Meeting One

Process and Site Selection

Key Principles and Patterns

During this first meeting, the Campus Planning Committee, with the guidance of Campus Planning and Facilities Management staff, will identify key principles, patterns, and other appropriate campus design issues from the Plan for user group consideration during project design. An important aspect of this meeting is identification of potential opportunities to address campus-wide needs within the subject area or opportunities to cooperate with other nearby development efforts. The committee also will review user group representation and provide comments to the user group chair as appropriate.

The committee may identify other appropriate issues to be considered and will review issues related to the siting of the building or the addition.

Site Selection and Site Specific Principles and Patterns

(a) Additions to Existing Buildings

Key patterns and principles that apply to the site will be identified.

(b) Stand-alone Buildings

The committee will review the preferred site (if there is one identified) and make a site recommendation for a stand-alone building. During its review the committee will identify the key patterns, principles, and other site-related campus design issues that should be as the project proceeds. The committee may appoint a separate group to work with Campus Planning staff, sponsor, user group members, committee members and other professional consultants as needed to review possible sites and recommend a preferred site to the Campus Planning Committee. The Campus Planning Committee will forward its site recommendation to the president.

STEP 3. Design - User Group

Project Description/Consultant Selection/Design

The user group serves as the client representative throughout the design process. The user group works with Campus Planning and Facilities Management staff to create a project description and with staff and members of the Campus Planning Committee to hire design consultants. The user group works directly with the consultant(s) to prepare a schematic design for Campus Planning Committee review. A site diagnosis shall occur prior to completion of a schematic design. (Refer to “Area and Site Diagnosis” on **page 34** for more information.)

STEP 4. Campus Planning Committee

Meeting Two Review, Notification, and Recommendation

The Campus Planning Committee will review all additions, major alterations, and new stand-alone buildings for conformance with the Plan. Following its review, the committee will make a recommendation to the president.

Subsequent changes to the design that meet the definition of a “minor alteration” are subject to review as described in Track A Minor Alterations.

Meeting Notification: Notice of all Campus Planning Committee review sessions will be given to members of the campus community who are most directly affected by the proposed development.⁵ Notice will be provided in the same way and at the same time to the Eugene planning director and to the designated representative of each affected neighborhood organization abutting the campus.

Additional notification requirements have been established for

- (a) construction proposals in the East Campus area as described in the *2003 Development Policy for the East Campus Area*, and

- (b) construction proposals that require land-use applications (for example, site reviews, conditional uses, zone changes, or traffic-impact analyses) as described in “Land-use Applications” **1**).

These provisions are not intended to restrict the delivery of notice to other individuals by other means. Additional notice and opportunity for public comment often are employed. For larger projects, this usually includes campus-wide public comment sessions prior to Campus Planning Committee review.

Appeals: A Campus Planning Committee recommendation to the president may be appealed as described in the “Campus Planning Committee” section on **page 23.**)

⁵ Members of the campus community most directly affected by the proposed project typically include the project sponsor and/or department head, the project user group chair, building managers of the project building and neighboring buildings, a Campus Planning and Facilities Services representative, the Department of Public Safety transportation coordinator, an ASUO representative, project planner, and any other individual who requests information. Each of these representatives is responsible for notifying additional faculty, staff, and students as he or she sees fit.

C Typically Privately Controlled On-campus Construction Projects and Off-campus Construction Projects on UO-owned Land

The following steps shall apply to projects that the president designates as Track C projects, typically privately controlled on-campus projects administered by the University of Oregon Foundation or other non-university entities and off-campus projects on university-owned land.

STEP 1. Director of Campus Planning

All capital construction proposals shall be referred to the Director of Campus Planning for a determination of the process to be followed.

The president has the authority to designate projects as Track C projects, which are typically private projects / off campus projects.

When projects are designated by the president as Track C, the project sponsor will work with the VP for Finance and Administration and the Director of Campus Planning to develop the following:

- (a) a written description of the project,
- (b) the method for managing the project and the degree of involvement of Campus Planning and Facilities Management,
- (c) a list of users to work with the selected design consultant,⁶
- (d) the method for selecting the design consultant, and
- (e) a preferred site for the project.

The VP for Finance and Administration will forward this information to the president, who will accept, modify, or reject it, establish a schedule for review, and forward the materials to the Director of Campus Planning for appropriate action.

STEP 2. Campus Planning Committee

Meeting One Process and Site Verification

The Associate VP for Campus Planning and Facilities Management and the president will determine whether the project is subject to Campus Planning Committee review and

recommendation. Meeting One is not applicable to minor off-campus projects.

When Campus Planning Committee review is required, the committee will meet with the project sponsor within the time frame established by the president and take the following actions:

- (a) review and comment on the list of proposed users and the design consultant selection process,
- (b) recommend principles, patterns, and other appropriate campus design issues either from the Plan or in general to be considered during the project's design, and
- (c) if the project is on campus, make a siting recommendation or establish a sub-group of committee members and others identified by the sponsor for the purpose of returning a site recommendation to the committee for its review and recommendation to the president.

President's Determination: After receiving the committee's comments and recommendations, the president will establish the users, the design consultant selection process, the principles, patterns, and other appropriate campus design issues either from the Plan or in general to be considered during the project's design. In the case of an on-campus project, the president also will make a final determination on the project's site.

STEP 3. Design

Consultant Selection/Design The selection of the designers and the design will proceed according to the approved process that was established during step 2.

STEP 4. Campus Planning Committee

Meeting Two

Review, Notification, and Recommendation

When Campus Planning Committee review is required, the committee will review the design of the project (most likely at the completion of the schematic design phase) within a time frame established by the president for

⁶ In keeping with established principles for the involvement of users in the design of projects, each privately controlled or off-campus project will include input from the expected users of the building. The intensity and frequency of this input may vary by project, but it is especially important that users have an active, meaningful role in the design of projects that house UO programs on off-campus, university-owned land. Such projects are different from on-campus projects, in which a user group is appointed by the Campus Planning Committee chair and includes users and other interested or affected parties.

compliance with the principles, patterns, and other appropriate campus design issues, as well as additional issues identified by the president. (See step 2 above.) Following its review, the committee will make a recommendation to the president.

Meeting Notification: Notice of all Campus Planning Committee review sessions will be given as required for additions/major alterations. (Refer to Track B, step 4, page 28.)

Amendments to the Plan

The review of amendments to or adoption of the Plan shall occur as described below. Amendments may result from a specific adjustment or as part of periodic plan review. (See “Periodic Plan Review” on page 32.)

Note: Amendments to the *Development Policy for the East Campus Area* shall follow the procedures contained within that document. Amendments to all other Subject Plans (e.g., the *Campus Tree Plan*) shall follow the same review process established for land-use applications and subject plans (see Land-use Applications and Subject Plans).

STEP 1. Director of Campus Planning

The Director of Campus Planning shall coordinate the review and approval process for all proposed amendments.

STEP 2. Campus Planning Committee Meeting One

Not applicable.

STEP 3. Design/Amendment Development

Although a user group is not applicable, an advisory group, focus groups, or Campus Planning Committee subcommittee may be established (for example, to provide input during a periodic review process) as determined necessary by the Director of Campus Planning and Campus Planning Committee. Interested parties should be identified and consulted prior to Campus Planning Committee review (e.g., Facilities Services, directly affected departments, etc.).

STEP 4. Campus Planning Committee Meeting Two

Review, Hearing, Notification, and Recommendation

Plan amendments shall be by action of the university president upon recommendation by the Campus Planning Committee.

Hearing: Before formulating a recommendation to the president, the committee shall hold a public hearing if the proposed amendment results in a change to a Plan principle or substantive amendments to patterns or principle refinements.

Meeting Notification: All Plan amendments shall follow the same notification procedures required for additions/major alterations (Track B, step 4, page 28).

When a Campus Planning Committee public hearing is required, notice shall be given to members of the campus community who are most directly affected by the proposed amendment. At least thirty days prior to the date of the hearing (unless otherwise required by the *Development Policy for the East Campus Area*), notice will be provided in writing to the director of the Eugene Planning Division and to a designated representative of each recognized neighborhood organization that abuts the campus. Notice of the hearing also shall be given by publication in the *Oregon Daily Emerald* at least ten days prior to the date of the hearing. Other means of providing notice of these hearings shall be employed to the maximum extent feasible.

The university will endeavor to provide opportunities for an exchange of information about proposals, separate from the required public hearings, as resources allow. These informational sessions will be held and publicized at times and places in a manner that will encourage maximum participation by the campus community and university neighbors.

Appeals: A Campus Planning Committee recommendation to the president may be appealed as described in the “Campus Planning Committee” section on page 23.)

Land-use Applications and Subject Plans

All land-use applications (such as site reviews,⁷ conditional uses, traffic-impact analyses, and zone changes submitted to the City of Eugene) and all Subject Plans (for example, principles or standards regarding campus lighting, the designation of historic buildings, or regions of campus) shall be reviewed in the manner described below.

East Campus Area Note: Refer to the *Development Policy for the East Campus Area* for amendments to the or land applications in the East Campus Area, refer to the document for specific notification requirements.

STEP 1. Director of Campus Planning

All land-use applications and Subject Plans shall be referred to the Director of Campus Planning for analysis of consistency with the provisions of the Plan and for a determination of the process to be followed.

STEP 2. Campus Planning Committee Meeting One

Not Applicable

STEP 3. Design/Plan Development

Although a user group is not applicable, an advisory group, focus groups, or Campus Planning Committee subcommittee may be established as determined necessary by the Director of Campus Planning and Facilities Management and Campus Planning Committee.

STEP 4. Campus Planning Committee Meeting Two

Review, Notification, and Recommendation

Land-use applications and Subject Plans shall be reviewed by the Campus Planning Committee in public sessions. This often occurs as part of a related construction project review.

Notification

All land-use applications and Subject Plans shall follow the same notification procedures required for additions/major alterations (Track B, step 4 above, page 28).

In addition, notice of the intent to apply to the

city for a site review, conditional use permit, zone change, or traffic-impact analysis shall be given to the adjacent designated neighborhood representatives at least thirty days prior to the date the application is filed with the city.

To the maximum extent possible, neighborhood concerns shall be addressed in the university's application to the city. Discussions with the neighborhood shall continue through the period during which the application is being processed by the city to the extent that they appear necessary to resolve outstanding issues.

The intent of this procedure is to allow for maximum participation of the neighborhood in the review of such proposals and to attempt to reach agreement with the neighborhood prior to city review. Campus Planning shall make every reasonable effort to arrange for a meeting or series of meetings between appropriate university officials and officially designated neighborhood representatives to discuss any such proposal and to resolve concerns that may be expressed.

⁷ Site review is required for specified parcels of land. In addition, when a proposed institutional use is located within 300 feet of property zoned residential and such use will generate the need for a traffic-impact analysis according to city code, the review process for development will involve site-review procedures as required by the city.

Periodic Plan Review

The Plan provides for regular and routine adjustments to reflect shifts in program requirements, enrollment levels and characteristics, and similar particulars. These continuous adjustments should occur as a result of the Plan's provisions for

- (a) regularizing the connection between the university's academic programs and physical planning processes,
- (b) preparing a *Biennial Capacity Plan* based on the capital construction budgeting process,
- (c) recognizing site and schematic plans for individual construction projects as refinements of this Plan, and
- (d) relying on the preparation and adoption of Subject Plans to articulate the Plan's more general principles.

Regardless of the flexibility built into this document, it is entirely possible that circumstances will change in ways and to an extent that would invalidate the basic assumptions and development objectives upon which the Plan is based. (Refer to Appendix C.) It will be important to regularly undertake periodic review of these fundamentals and to modify the planning principles as warranted.

Changes of this sort are more likely to result from shifts in attitudes, perceptions, programs, and directives from outside the institution than from changing directions within the university. In order to be in a better position to predict and understand the consequences of these external pressures, the Plan provides for sustained involvement of the larger community in the campus planning process. This involvement also should be viewed as a vehicle within which the university can serve as a responsible, proactive agent.

Academic Planning Coordination

The principle of diagnosis is embodied in the academic planning coordination, diagnosis, and periodic plan-review requirements as described below.

At the conclusion of an academic program planning cycle, the Office of the Provost and affected program units shall notify the Campus Planning Committee of possible Plan modifications that appear to be necessary or warranted in order to more appropriately support the academic program. The committee may, upon its own motion or upon request of the provost, institute the process of amending the Plan.

The following studies will be prepared to enhance coordination between academic and physical campus planning endeavors:

(a) Capital Construction Budget Request

Each biennium, as part of the preparation of the university's capital construction budget proposal, project proposals received from academic units and prioritized by the administration will be referred by the president to the Campus Planning Committee for review and comment about the relevant plan principles and patterns to determine if:

- (1) sufficient land exists, in aggregate, to accommodate the prioritized first-biennium capital construction projects,
- (2) each capital building project proposed for funding in the first biennium has siting opportunities that are consistent with the Plan, and
- (3) any of the prioritized capital construction projects would require plan amendments, and if so, to provide comments.

(b) Biennial Capacity Plan (BCP)

As a means for examining the campus's capacity and the ongoing effectiveness of the Plan, Campus Planning and Facilities Management shall prepare a *Biennial Capacity Plan* for review by the Campus Planning Committee. The *Biennial Capacity Plan* will contain the following information:

- (1) a program-specific site or alternative sites for each project proposed for first-biennium funding (identification of these siting opportunities does not preclude development of the project on another site that is consistent with the Plan should more detailed design studies indicate the desirability of a different location),
- (2) identification of sufficient siting opportunities to accommodate proposed developments for projects either proposed for funding in subsequent biennia or identified as needed by a sponsoring unit, and
- (3) a calculation of the speculative maximum build-out of the campus including all identified projects from (1) and (2) above and also including buildings representing the maximum density as listed in the plan for the campus. (See "Principle 3. Densities," page 49.)

Upon reviewing the *Biennial Capacity Plan*, the Campus Planning Committee shall determine that

- (1) sites meeting the requirements of the Plan are identified for the first-biennium projects, or, revisions are identified if they are needed, and
- (2) in the aggregate, sufficient siting opportunities exist for the remaining identified capital projects.

If capacity is needed or appropriately located sites are not available, the Campus Planning Committee shall consider amendments to the Plan.

Community Coordination

The Plan recognizes that some university construction principles and activities affect adjacent neighborhoods and the community as a whole. It also recognizes that institutional requirements should be coordinated with established principles and plans adopted by the larger community.

- (a) The university adopts by reference applicable community planning documents (listed in Appendix J) as they pertain to the University of Oregon and to adjacent lands as they now exist or may be amended hereafter.
- (b) The University/Community Liaison Committee (U/CLC) is comprised of representatives from the university, the city, and various local organizations and institutions representing people who live and work in the university area.⁸ Its primary function is to provide a forum for participants to share information about development priorities and activities. The university will continue university representation on the U/CLC.
- (c) Regular contact among the leadership of state and local governments and campus area neighborhood organizations provides an additional opportunity for monitoring development activities.
- (d) Specific notification requirements for construction projects, land-use applications, and plan amendments are described earlier in this chapter.

Area and Site Diagnosis Studies

- (a) Areas of the campus shall be studied periodically for their health. These diagnostic studies shall enumerate shortcomings and assets contained within the study area.

These studies allow for the identification of areas needing repair. This in turn opens possibilities for site repair as part of future construction projects in the area. In this way individual projects contribute to the improvement of the campus as a whole.

Area diagnosis studies are prepared by and available from Campus Planning and Facilities Management for use when initiating a construction project. They are intended to be initial analyses; therefore, they are not subject to Campus Planning Committee Review.

- (b) A site diagnosis in appropriate scope and detail shall precede the development of schematic designs for any project.

⁸ The University/Community Liaison Committee membership consists of representatives from the adjacent neighborhood associations, University of Oregon, Northwest Christian University, Peace Health University District, the University Area Small Business Association, and the Eugene Planning Commission.

PRINCIPLE 2



OPEN-SPACE FRAMEWORK

PRINCIPLE 2: OPEN-SPACE FRAMEWORK



Principle

The University of Oregon campus is organized as a system of quadrangles, malls, pathways, and other open spaces and their landscapes. This organizational framework not only functions well, but also serves as a physical representation of the university's heritage.

As opportunities arise, the fundamental and historic concepts of the university's open-space framework and its landscape shall be preserved, completed, and extended. All development projects shall follow the principle refinements below.

Pattern Summary

(Refer to "Principle 11: Patterns" on page 91 for the complete pattern text.)

- Access to Water
- Accessible Green
- Activity Nodes
- Bike Paths, Racks, and Lockers
- **Building Complex**
- Campus Trees
- **Connected Buildings**
- Family of Entrances
- Good Neighbor
- Hierarchy of Streets
- Local Sports
- **Local Transport Area**
- Looped Local Roads
- **Main Building Entrance**
- Main Gateways
- Open University
- **Open-space Framework**
- Outdoor Classroom
- Path Shape
- Paths and Goals
- Pedestrian Pathways
- **Positive Outdoor Space**
- Promenade
- Public Outdoor Room
- Quadrangles and the Historic Core

- **Quiet Backs**
- Road Crossings
- Seat Spots
- **Site Repair**
- Sitting Wall
- Small Public Squares
- **South Facing Outdoors**
- Tree Places
- University Shape and Diameter

Principle Refinements

The following principle refinements provide a series of steps to identify, preserve, and expand the open-space framework consisting of Designated Open Spaces and Pathways. The key components of the open-space framework – quadrangles, axes, promenades, greens, and natural areas – are covered as well.

The principle refinements also identify key considerations for landscape design.

Designated Open Spaces

- (a) Identify: Map 3 (**page 39**) identifies the significant open spaces on campus, which are the fundamental and historic open spaces within the university's open-space framework. Descriptions of these spaces, known as Designated Open Spaces, can be found within "Principle 12: Design Areas Special Conditions" (page 111).
- (b) Protect: No development (enclosed building space) shall occur in these Designated Open Spaces unless an exception is noted in "Principle 12: Design Areas Special Conditions" (page 111).
- (c) Enhance: In the absence of a source of funding to create, improve, and expand Designated Open Spaces, individual

construction projects are responsible for contributing to their development and improvement. All construction projects must enhance (create, improve, or expand) open spaces within their Design Area as part of the project scope as described in “Open Space Enhancement Requirements” (page 44).

- (d) **Form and Character:** Proper design of open spaces is essential to their success as individual spaces and, more importantly, as a cohesive open-space framework. All projects shall consider the design parameters described in “The Forms and Character of Designated Open Spaces” (page 42), “Principle 7: Architectural Style and Historic Preservation,” and “Principle 12: Design Area Special Conditions” (page 111).
- (e) In addition to Designated Open Spaces, which are intended for use by all campus users, smaller open spaces frequently are integrated into the design of new construction. These include the courtyards at the Education complex, Lawrence Hall, and the Knight Law Center. Because such spaces are primarily for use by building occupants, they may not qualify as Designated Open Spaces. However, their enhancement and creation are encouraged, and a project’s responsibility in contributing to the development, improvement, or expansion of Designated Open Spaces should not be seen as a substitute for the development of smaller, project-associated open spaces.
- (f) Spaces used as outdoor classrooms are also important. (Refer to “Outdoor Classrooms” on page 58.)

Pathways

- (a) **Identify:** Pathways that provide connections between open spaces are designated on Map 4 (page 41).
- (b) **Preserve:** Connections essentially similar to those shown on Map 4 are to be preserved. While the path location or shape may change, the connection is to remain.

- (c) **Enhance:** All development projects must consider the pathway needs of the area in which they are located. Extending or improving existing pathways or creating new ones is to be considered during project design.

Campus Edges

The look and feel of campus edges have a significant impact on the campus environment as well as the greater community.

- (a) Campus edges are the parts of campus that are most visible to the public. Every opportunity should be taken to improve views into and out of the campus. The overall quality of the edges is most important, whether open spaces, buildings, or landscape features define them.
- (b) It is important for the university, a public institution, to maintain a positive and visible association with the adjacent community and the general public. The campus edges should convey the university’s public role, its mission, and its history. The character-defining features of the campus’s open spaces, landscapes, and building designs should be evident at the campus edges.
- (c) The transition between the campus and the community should encourage a positive interaction between the two. Although it may not be desirable to establish a strong boundary between the campus and community (see Open University pattern), it is beneficial to identify the campus edges through welcoming gateway elements and other design features.
- (d) The primary edges are identified on the Campus Edges diagram (page 41). Each edge has unique features and design issues that should be addressed. All development shall adhere to the special-edge design considerations defined in “Principle 12: Design Area Special Conditions” (page 111). In addition, refer to related City of Eugene policies and plans listed in Appendix J.

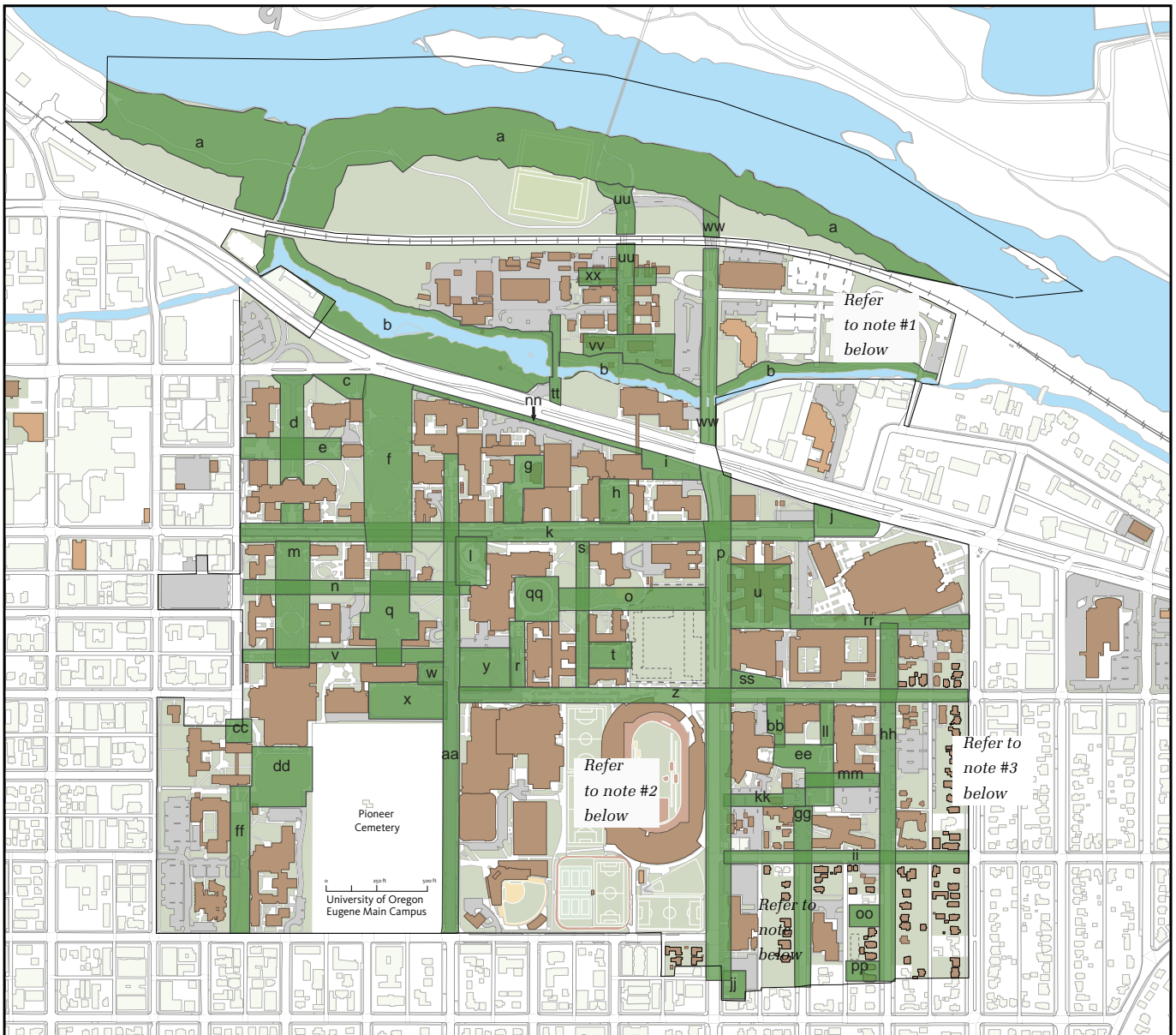

a. Willamette Natural Area	n. Johnson Lane Axis	aa. University Street Axis	nn. Franklin Boulevard Axis
b. Millrace Natural Area	o. Promenade	bb. Glenn Starlin Green	oo. Moss Green
c. Villard Hall Green	p. Agate Street Axis	cc. Kincaid Green	pp. Garden Green
d. Dads' Gates Axis	q. Women's Memorial Quadrangle	dd. Southwest Campus Green	qq. EMU Green
e. University Hall Walk Axis	r. Onyx Axis	ee. East Campus Green	rr. 14th Avenue Axis
f. Old Campus Quadrangle	s. Emerald Axis	ff. Southwest Campus Axis	ss. DeNorval Unthank Jr. Residence Hall Green
g. Onyx Green	t. Living Learning Center Green	gg. Columbia Axis	tt. Onyx Axis
h. Science Green	u. New Green (Name TBD)	hh. Moss Axis	uu. Riverwalk Axis
i. Agate Entrance Green	v. Knight Library Axis	ii. 17th Avenue Axis	vv. Millrace Green
j. Bakery Park Green	w. Gerlinger Entrance Green	jj. Agate Hall Axis	ww. Riverfront Parkway Axis
k. 13th Avenue Axis	x. Gerlinger Field Green	kk. Agate to Columbia Axis	xx. North Green
l. Amphitheater Green	y. Straub Hall Green	ll. East Campus Axis	
m. Memorial Quad	z. 15th Avenue Axis	mm. Many Nations Longhouse	

Map 3: Designated Open Spaces



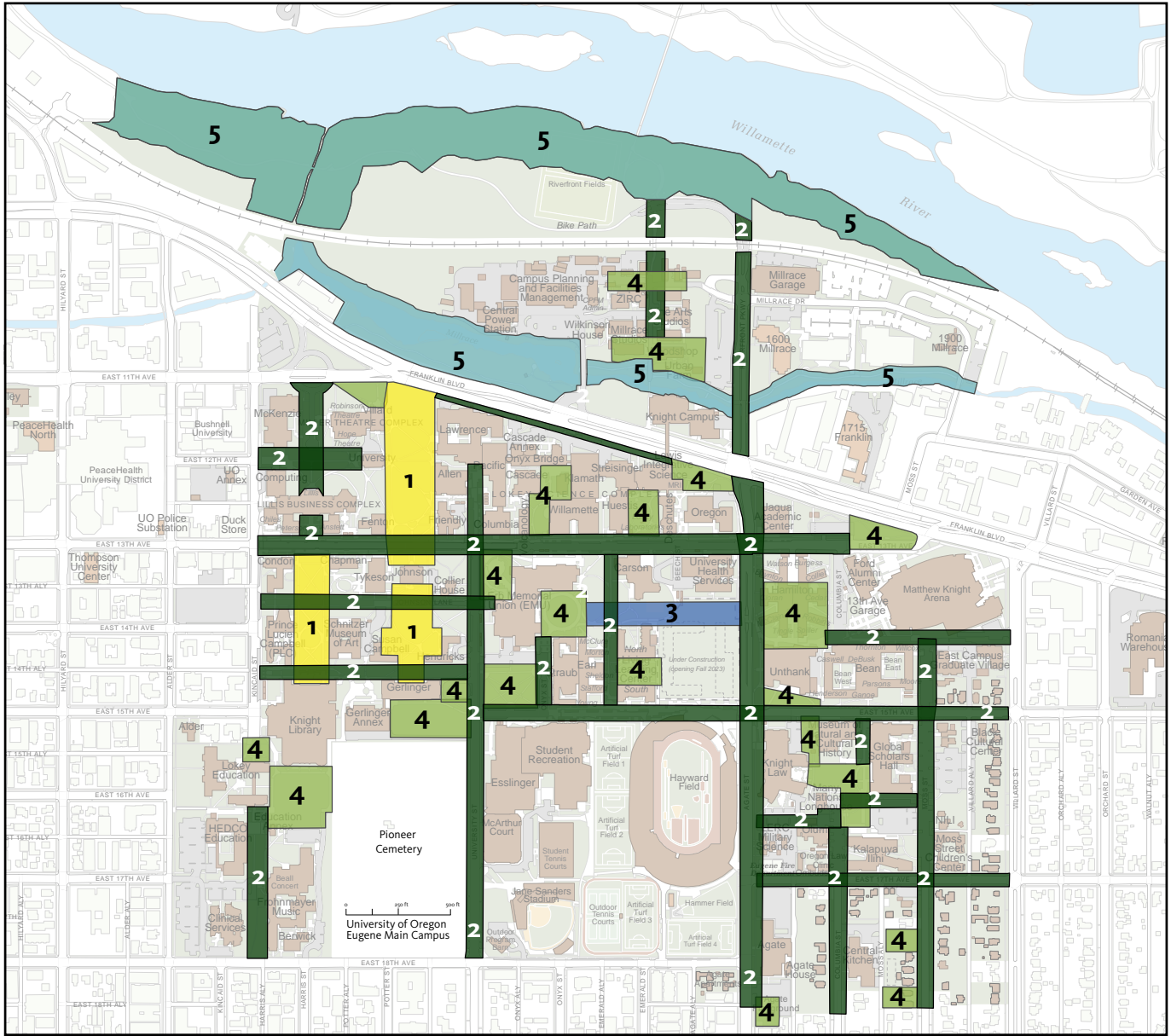

Notes:

1. The open-space framework in the North Campus Area is largely undeveloped. Refer to the *North Campus Conditional Use Permit* and the *Campus Physical Framework Vision Project (2016)* for additional information.
2. Refer to the *University Street Feasibility Study (2012)* and the *Campus Physical Framework Vision Project (2016)* for additional information about the potential expansion of the open-space framework in the Esslinger Hall and Mac Court area.
3. The open-space framework in the outer portions of the East Campus Area are largely undeveloped. Refer to the *Development Policy for the East Campus Area*, the *East Campus Open Space Framework Study (2004)*, and the *Campus Physical Framework Vision Project (2016)* for additional information.



Map 3.1: Designated Open Spaces by Type

- 1. Quadrangles
- 2. Axes
- 3. Promenades
- 4. Greens
- 5. Natural Areas

KEY	
Designated Open Space Types	
	Quadrangles
	Axes
	Promenades
	Greens
	Natural Areas

Map 4: Pathways

Note:

1. Refer to the *University Street Feasibility Study* (2012) and the *Campus Physical Framework Vision Project* (2016) for additional information about the potential expansion of the open-space framework in the Esslinger Hall and Mac Court area.
2. The open-space framework in the outer portions of the East Campus Area are largely undeveloped. Refer to the *Development Policy for the East Campus Area*, the *East Campus Open Space Framework Study* (2004), and the *Campus Physical Framework Vision Project* (2016) for additional information.

PRINCIPLE 2

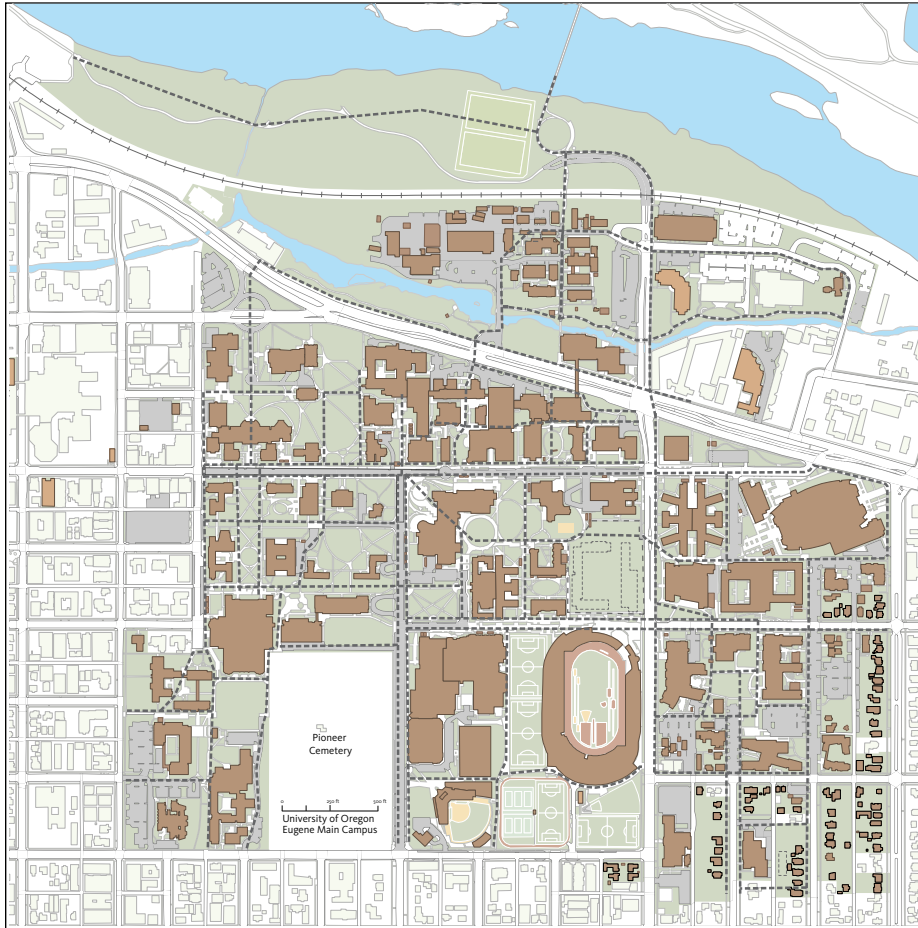

Diagram of Campus Edges



The Forms and Character of Designated Open Spaces

The campus is developed around a series of open spaces connected by pathways. This system is the framework that dictates the arrangement of buildings. Public open spaces are intended for use by the entire campus community. The Campus Plan refers to these spaces as Designated Open Spaces and Pathways (refer to Maps 3 and 4 on pages 39 and 41).

Public and Welcoming: The most important aspect of these spaces is that they feel as though they are public and that they are welcoming to anyone who would pass through or spend time in them. They should not give the impression that they belong to the occupants of nearby buildings, although those kinds of spaces also exist and are to be encouraged as well.

Connected: An important characteristic of public spaces is that of allowing people to pass through them. They should not be dead-end spaces and should always include a connection to other spaces along one edge or through one end.

Use and Environmental Benefits: The intended use (active/passive) and environmental benefits

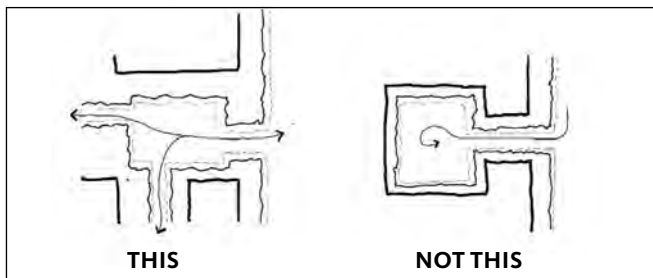

(for example, light and wind) of the open spaces are important considerations.

Forms: The campus is home to four primary types of Designated Open Spaces:

- Quadrangles
- Axes
- Promenades
- Greens
- Natural Areas

QUADRANGLES

(Memorial Quad, Old Campus Quad, Women's Memorial Quadrangle)

Quadrangles are rectangular open spaces that are formed by the fronts of three-story or four-story buildings on the long sides and by monumental buildings at one or both ends. Typically, axes cross a quadrangle, connecting it

to other axes, quadrangles, or open spaces. The width (shorter distance) of quadrangles should be perceived as being flat. Quadrangles can contain formal (symmetrical or geometric) or informal (irregular or natural) sidewalk arrangements and plantings. The buildings along a quadrangle's edge should have their main entrances facing the quad, thereby reinforcing its importance and bringing activity into it. Building sites on established quadrangles should be reserved for significant academic buildings.



Quadrangle (formal): Memorial Quad



Quadrangle (informal): Old Campus Quad

AXES

(13th, 15th, 17th, Agate, Agate to Columbia, Columbia, Dads' Gates, University Hall Walk, East Campus, Emerald, Franklin Boulevard, Johnson Lane, Knight Library, Many Nations Longhouse, Moss, Onyx, Riverfront Parkway, Riverwalk, Southwest Campus, University Street)

Axes are longer and narrower than quadrangles. They serve primarily to interconnect other open spaces on the campus. They are typically

rectangular and contain informal or formal sidewalks and plantings. They often contain a long view of the campus. Many campus axes either currently are or at one time were streets. Buildings may have front entrances facing an axis, but buildings that front both an axis and a quadrangle should always have their main entrances facing the quadrangle.



Axis: 13th Avenue Axis

PROMENADES

Promenades are less formal axes that connect open spaces. They typically are large-scale pathways. Their plantings are largely informal, as are the sidewalks within them.



Promenade

GREENS

(Agate Entrance, Agate Hall, Amphitheater, Bakery Park, East Campus, EMU, Garden, Gerlinger Entrance, Gerlinger Field, Glenn Starlin, Humpy Lumpy, Kincaid, Living/Learning Center, Millrace, Moss, North, Science, Southwest Campus, Straub Hall, Villard Hall)

Greens are significant public open spaces that are larger than a private courtyard yet smaller than a quadrangle. Some greens may share many of the aspects of quadrangles while others function more like plazas. In some cases

the buildings surrounding them lack the scale that would give them the formal presence of a quadrangle. In most cases they are informally planted and may have an irregular form.



Green: Amphitheater Green



Green: East Campus Green

NATURAL AREAS

(Willamette Natural Area, Millrace Natural Area)

Natural Areas are open spaces dedicated to preserving and restoring natural habitat and promoting ecological functions, while providing opportunities to learn about and engage with natural systems. Examples of opportunities to engage include outdoor instruction and research, stewardship, walking and bicycling, and other activities associated with being in nature (e.g. personal paddle craft, bird watching, art, etc.). Their form, and often topography, is irregular and typically defined by waterways and adjacent riparian and upland areas. Pathways are typically

informal in configuration and need to balance safe access with consideration for ecological impacts. Native plants, which support a wide variety of wildlife, in particular endangered or threatened species, will be prioritized and conserved as practicable. Unlike other open space types, adjacent development does not play a prominent role in the definition of the open space's form. Adjacent development should be designed with particular attention to views of, and connections to, Natural Areas. Adjacent light spillover into the open space should be minimized as much as practicable.



Natural Area: Millrace Natural Area



Natural Area: Millrace Natural Area

Open-space Enhancement Requirements

All new construction development projects must enhance or establish Designated Open Spaces within their Design Areas as part of the project scope. This requirement is in addition to enhancing or establishing landscaping within the immediate building site (entrances, foundation plantings, small courtyards, etc.).

When a project's schematic design is reviewed by the Campus Planning Committee, the



Natural Area: Willamette Natural Area



Natural Area: Willamette Natural Area

committee will determine that the following minimum standards for enhancing Designated Open Spaces are being met. The committee may take the additional step of recommending to the president that sufficient funding be established within the project budget to accomplish these improvements and that this funding be protected should the project face budget reductions during subsequent design or construction phases.

Requirements for open-space enhancement and development in the East Campus Area are elaborated in the *2003 Development Policy for the East Campus Area*.

- (a) As a general rule (subject to Campus Planning Committee interpretation), each project (or complex of buildings) must include the enhancement or construction of adjacent Designated Open Space in the project scope of the new construction size listed below (this may be part of a larger open space):

MINIMUM REQUIRED DESIGNATED OPEN SPACE:

Building Size (gsf)	Minimum Required Designated Open Space (sf)
0 - 24,999	10% of gsf
25,000 - 49,999	12% of gsf
50,000 - 99,999	14% of gsf
100,000 and up	16% of gsf

- (b) This standard is intended to provide guidance for the minimum Designated Open Space to be enhanced or constructed. It is not intended to limit the amount of additional quality open spaces that will occur during the course of development. At the discretion of the Campus Planning Committee, required construction or enhancements may occur in adjacent Design Areas.
- (c) Additionally, in Design Areas where 25 percent of the available uncovered land is already established as a Designated Open Space and improvements are not required, the Campus Planning Committee shall recommend where additional open space should be built or enhanced in an adjacent Design Area.

Landscape

All building projects must include an appropriate budget to install a landscape plan that meets the Plan patterns and principles.

PLANT MATERIALS

- (a) Landscape materials are assets to the campus and are to be carefully selected and properly maintained. The university campus is in fact an arboretum. The plant materials on the campus have an aesthetic

significance and constitute a valuable teaching resource.

- (b) Vegetation should be planted and managed to avoid excessive damage to buildings, reduce susceptibility to pest infestation, minimize reliance upon the use of pesticides, and contribute to the aesthetic quality and enjoyment of the campus as a whole. Refer to the Campus Construction Standards.
- (c) Landscaping quickly loses its value if it is not well maintained. Materials likely to require excessive maintenance should be avoided or judiciously located.
- (d) Appropriate Facilities Services personnel shall be consulted before planting any new plant materials on the campus.
- (e) Whenever possible and appropriate, plant materials are to be used to screen such uses as parking lots and service areas and to soften the visual impact of fences and similar barricades.
- (f) In approving a schematic design that requires the removal of trees or significant plant materials, the Campus Planning Committee shall be satisfied that alternative designs not involving the removal have been prepared and carefully explored and that the Tree Replacement Requirements have been met. Refer to the *Campus Tree Plan*.
- (g) Trees that help form or reinforce the identity of Designated Open Spaces and Pathways are significant trees and are to be afforded extra care. Refer to “Principle 12: Design Area Special Conditions” (page 111) and the *Campus Tree Plan*.
- (h) When proposed development may negatively impact trees, it is important to define the significance of the affected trees. Every effort should be made to preserve significant trees. Significant trees include those that have historical association, have educational value, are an excellent species example, or are designated in memory or in honor of an individual. Refer to the *Campus Tree Plan* for a complete description of the required steps.

- (i) Select and position landscape materials to aid in achieving energy efficiency. Take advantage of trees to reduce cooling loads and use hedgerows or shrubbery to help channel cool summer breezes into the building.
- (j) Protect wetlands, wildlife habitats, and watersheds to the greatest extent possible.
- (k) Consider how the landscaped areas are linked to one another and create natural corridors for plants and birds. Integrate bird food sources and shelter. Tie these corridors in with the established open-space framework.
- (l) Use native or well-adapted species for landscaping when appropriate while recognizing the importance of a variety of plant materials necessary for instructional use.
- (m) Maintain an Integrated Pest Management approach, which carefully considers plant selection and design and minimizes use of herbicides, pesticides, fertilizers, and irrigation.
- (n) Work to preserve the integrity of the site, in particular trees, significant plant materials, and topsoil. First consider development on previously disturbed areas.

LANDSCAPE FIXTURES

(benches and other site furniture, signs, etc.)

- (a) Properly placed and designed, benches and other outdoor accessories enhance the appearance and use of campus open space. Bench and accessory designs such as such as bollards and trash receptacles, need to respond to the intensity of their expected use and the context in which they are located. (Refer to the Campus Design Standards for a description of the approved campus standard designs. Seating integrated into the landscape or building design (for example, seating walls) is encouraged. In the absence of an adopted standard design or plan for outdoor furnishings and accessories the design and installation of such items are to be approved on a case-by-case basis in a manner authorized by the Campus Planning Committee. (Refer

to the diagram of Campus Planning Documents on page 12).

- (b) The purpose of signage on campus is to ensure safety, provide direction, and provide information about campus departments and events. Every effort shall be made to limit signage on campus with the understanding that some signage is essential to support the university's mission. All proposals for exterior signage not covered by the campus standard designs shall be approved on a case-by-case basis in a manner authorized by the Campus Planning Committee. (Refer to the *Campus Outdoor Sign Plan*.)

CAMPUS SAFETY/ENVIRONMENTAL DESIGN

The university acknowledges the need for the campus to be as safe and comfortable as possible at all times of the day and evening. Campus buildings and landscapes should be designed with this in mind. Campus security professionals and planning staff will work collaboratively to develop a safe, comfortable, and beautiful campus.

- (a) Vegetation should be planted and managed in a way that eliminates conditions that lead to personal safety concerns yet contributes to the aesthetic enjoyment of the campus as a whole.
- (b) The university recognizes the necessity of campus lighting and exterior building lighting to address adequately the personal safety requirements of students, faculty, staff, and campus visitors without significantly damaging its nighttime aesthetic qualities, as well as to be consistent with its commitment to energy conservation. The campus standard fixture is free standing; building-mounted fixtures are to be avoided. (Refer to the separate *Campus Outdoor Lighting Plan* and the Campus Design Standards.)
- (c) The system of emergency call boxes should be preserved and expanded. (Refer to the Campus Design Standards for the campus standard design.)
- (d) Appropriate University of Oregon Police Department and Facilities Services personnel shall be consulted before installing safety systems or altering vegetation.

PRINCIPLE 3

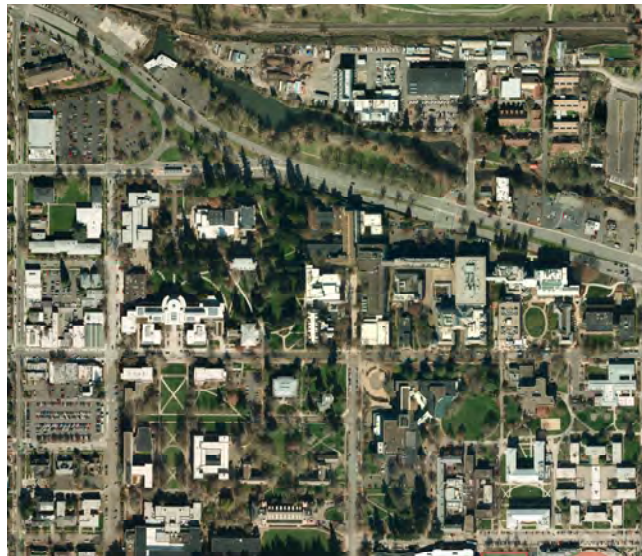

DENSITIES

PRINCIPLE 3: DENSITIES



Principle

Development densities are established to preserve the historic character of the university campus as a setting conducive to thoughtful and reflective endeavor, while at the same time allowing for accommodation of new facilities.

To control the look and feel of the campus, no construction project shall result in a density in excess of the maximum densities established below.

Pattern Summary

(Refer to “Principle 11: Patterns” on page 91 for the complete pattern text.)

- **Four-story Limit**
- **Future Expansion**
- Outdoor Classroom
- **Open-space Framework**
- **Sustainable Development**
- University Shape and Diameter
- **Use Wisely What We Have**

Principle Refinement

The following principle refinements establish allowed densities.

- (a) The campus is divided into Design Areas (Map 5 on page 50) to address localized conditions and define appropriate development densities. No development shall result in a density exceeding the allowed maximum densities established for each Design Area (Table 2 on page 51). A maximum building footprint (SF) and maximum gross square footage (floor area ratio) are established for each Design Area.
- (b) Desired maximum densities also are defined for each sub-area within the Design Areas as of the time of this Plan. These desired maximums (Table 2) will

change over time as new projects are built. Refer to the most recent *Biennial Capacity Plan* for updated desired maximums.

East Campus sub-areas have maximum allowed densities instead of desired maximums as defined by the *Development Policy for the East Campus Area*.

- (c) Basements and all structures with roofs (including grandstands and parking structures) are included in density calculations. Basements and covered walkways/arcades are to be encouraged because they preserve open space and reduce density above ground. Accordingly, projects designed with basements may request from the Campus Planning Committee additional gross square footage allotments beyond the established maximums, although automatic acceptance by the committee is not implied.

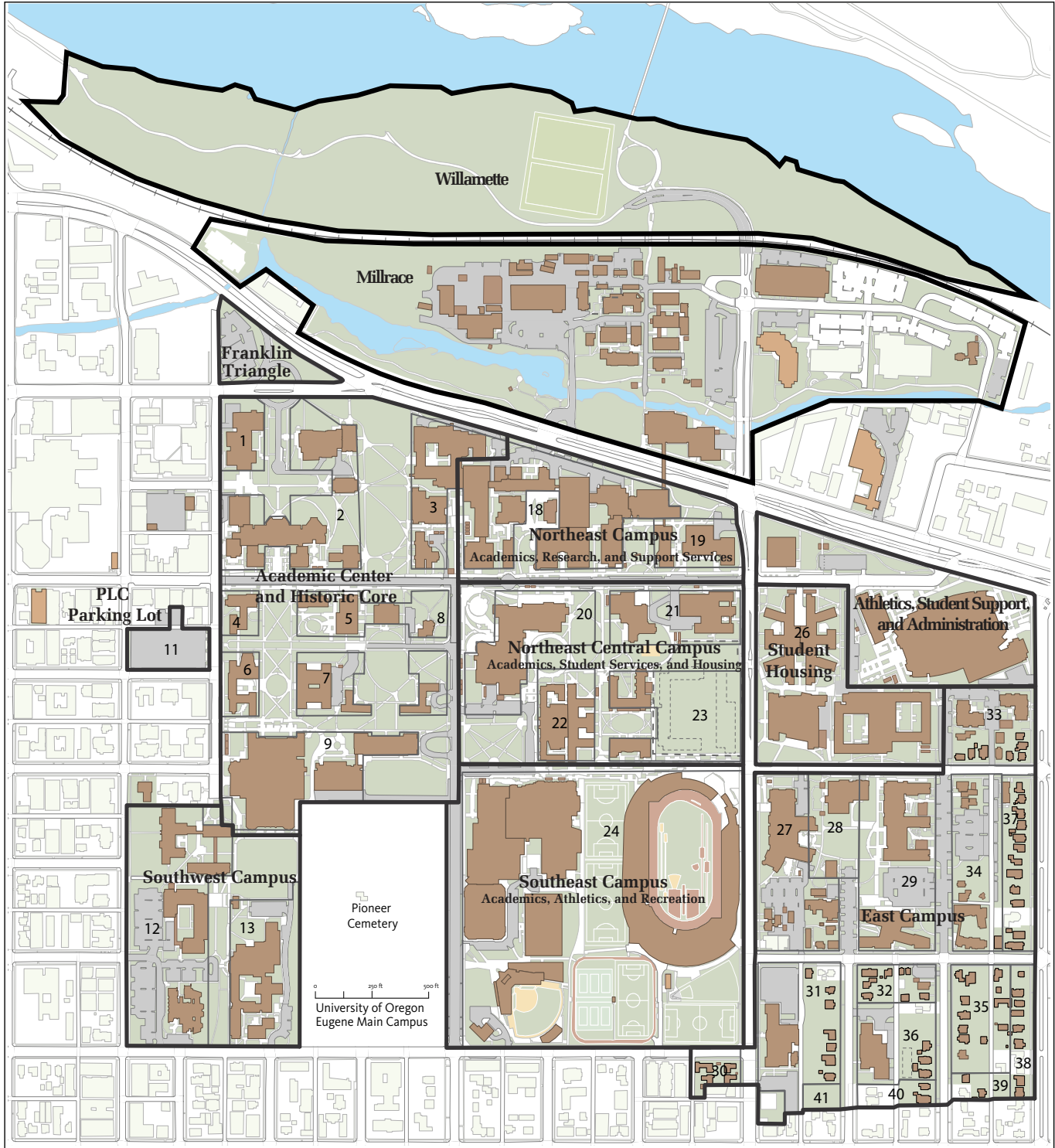

Map 5: Design Areas

Notes: Sub areas were renumbered (no area boundaries were changed) The new numbers on East Campus (shown above) correspond to the old numbers as follows (old numbers are in parentheses): 27 (73), 28 (71), 29 (72), 30 (43), 31 (74), 32 (75), 33 (51), 34 (52), 35 (53), 36 (54), 37 (55), 38 (56), 39 (57), 40 (58), and 41 (59).

The sub-areas within the East Campus Design Area include designated open spaces and have maximum allowed densities as defined by the Development Policy for the East Campus Area.

Table 2: Design Area Development Densities

DESIGN AREA	SUB AREA	SIZE (total square feet (sf) in design area)	MAX BUILDING FOOTPRINT (sf)		MAX GROSS SQUARE FOOTAGE		2022 AVAILABLE BUILDING FOOTPRINT (see notes 1, 4)	2022 AVAILABLE gsf (see notes 1, 4)	NOTES
			% coverage allowed	sf (size x %)	floor area ratio	gsf (size x ratio)			
ACADEMICS CENTER and HISTORIC CORE		1,827,250	28% (.28)	511,630	.975	1,781,568	30,965	202,431	
							Desired	Desired	
	1						7,500	30,000	
	2						6,630	9,129	
	3						7,000	30,000	
	4						5,000	15,000	
	5						0	0	
	6						1,000	5,000	
	7						10,000	40,000	
	8						12,000	45,000	
	9						0	60,000	
FRANKLIN TRIANGLE (Parking) FRANKLIN TRIANGLE		97,977	30% (.30)	29,900	1.80	179,400	29,900	179,400	See notes 2, 3.
		97,977	50% (.50)	49,000	2.00	--	49,000	--	
PLC PARKING LOT (Parking) PLC PARKING LOT	11	59,292	75% (.75)	44,469	4.00	237,168	44,469	237,168	See note 2.
		59,292	50% (.50)	29,646	2.00	118,584	29,646	118,584	
SOUTHWEST CAMPUS		694,055	30% (.30)	208,217	.800	555,244	51,494	218,269	
							Desired	Desired	
	12						24,353	135,019	
	13						33,769	77,612	
MILLRACE		2,093,000	22% (.22)	450,000	.83	1,700,000	--	--	See note 6.
WILLAMETTE		1,860,000	4% (.04)	68,600	.11	199,800	--	--	See note 6.
NORTHEAST CAMPUS (ACADEMICS, RESEARCH, and SUPPORT SERVICES)		580,363	41.5% (.415)	240,850	1.70	986,617	1,243	9,996	
							Desired	Desired	
	18						0	0	
	19						23,500	93,000	

PRINCIPLE 3

DESIGN AREA	SUB AREA	SIZE (total square feet (sf) in design area)	MAX BUILDING FOOTPRINT (sf)		MAX GROSS SQUARE FOOTAGE		2022 AVAILABLE BUILDING FOOTPRINT (see notes 1, 4)	2022 AVAILABLE gsf (see notes 1, 4)	NOTES
			% coverage allowed	sf (size x %)	floor area ratio	gsf (size x ratio)			
NORTHEAST CENTRAL CAMPUS (ACADEMICS, STUDENT SERVICES, and HOUSING)		1,016,396	33% (.33)	335,411	1.13	1,148,527	45,798	147,784	
							Desired	Desired	
	20						---	---	
	21						---	---	
	22						---	---	
	23						---	---	
SOUTHEAST CAMPUS (ACADEMICS, ATHLETICS, and RECREATION)	24	1,515,345	44% (.44)	667,077	.81	1,220,353	25,399	451,175	
ATHLETICS, STUDENT SUPPORT, & ADMINISTRATION	-	514,434	39% (.39)	198,300	1.20	612,800	14,395	80,652	
STUDENT HOUSING	26	418,270	36% (.36)	150,577	1.24	518,655	(-38,098)	(-70,124)	See note 5.
EAST CAMPUS		1,291,771	*	462,478	*	1,073,178	133,768	405,240	(Sub-areas 27-36). See note 7.
	27	198,581	35% (.35)	69,503	1.25	248,226			
	28	106,146	35% (.35)	37,151	.500	53,073			
	29	261,005	38% (.381)	99,443	1.29	336,697			
	30	23,252	30% (.30)	6,976	.600	13,951			
	31	186,980	40% (.40)	74,792	.750	140,235			
	32	48,000	50% (.50)	24,000	.700	33,600			
	33	116,243	30% (.30)	34,873	.600	69,746			
	34	164,096	30% (.30)	49,229	.500	82,048			
	35	94,094	30% (.30)	28,228	.500	47,047			
	36	93,374	41% (.41)	38,283	.52	48,555			
	37-41	See East Campus Development Policy							

NOTES:

1. Available footprint (sf) and gsf will need to be calculated as each project is planned. Refer to the most recent *Biennial Capacity Plan* (BCP) and the Campus Physical Framework Vision Project (FVP) for the current information. Desired footprint (sf) and gsf are calculated as of the date of the Plan. Desired maximums are included here to serve as a record of the intent of the Campus Planning Committee when the Plan was made. Subsequent Campus Planning Committees, informed by future BCPs, may come to different conclusions. Also refer to the BCP for the size of each sub-area.

2. Design Areas expecting to contain structured parking are assigned higher allowable densities only for parking structures for two reasons. First, floor-to-floor heights of parking structures are lower than regular buildings (E.g. Academics), resulting in a six-level parking structure being a similar height to a four-story building. Second, while cost is not a factor in most instances, the cost of structured parking is very high, and maximizing the size of each parking structure creates efficiencies in its design.

3. The table shows maximum allowable density for a parking structure and a regular building (E.g. Academics). If a parking structure is incorporated into a regular building, the parking shall not exceed the maximum allowable density for parking in this design area. Maximum FAR would depend on the ratio of non-parking to parking use, assuming a regular building of four stories, and a parking structure of six stories.

4. Available footprint equals the area's allowed footprint minus the existing building footprints according to the *2021-23 Biennial Capacity Plan*. Available gross square feet equals the area's size times the ratio minus the existing gross square feet 2021-23 *Biennial Capacity Plan*.

5. There is a deficit in available building footprint and gsf in the Student Housing Design Area because the DeNorval Unthank Jr. Residence Hall, completed in 2021, was approved by the Campus Planning Committee with the understanding that Hamilton Hall would be demolished after completion of phase II of the Housing Transformation Project (Walton Hall replacement).

6. The Willamette and Millrace Design Areas are regulated by the North Campus Conditional Use Permit (CUP). For more detail about maximum densities in these design areas, refer to the North Campus CUP.

7. East Campus sub-areas have maximum allowed densities instead of desired maximums. Refer to the *Development Policy for the East Campus Area*.

PRINCIPLE 4



SPACE USE AND ORGANIZATION

PRINCIPLE 4: SPACE USE AND ORGANIZATION



Principle

When a university is too spread out, people cannot make use of all it offers. On the other hand, a campus diameter based strictly on the ten-minute class break is needlessly restrictive. The location of program spaces greatly affects how the campus functions and influences the degree of positive interaction.

In order to distribute the campus's available space in ways that are functional, flexible, and compatible, all proposed projects and space assignments shall meet the principle refinements below.

Pattern Summary

(Refer to "Principle 11: Patterns" on page 91 for the complete pattern text.)

- **Building Hearth**
- Classroom Distribution
- Enough Storage
- Fabric of Departments
- Faculty-Student Mix
- **Flexibility and Longevity**
- No Signs Needed
- Office Connections
- **Organizational Clarity**
- Outdoor Classroom
- Places to Wait
- Pools of Light
- Public Gradient
- **Quality of Light**
- Student Housing
- University Shape and Diameter

Principle Refinements

The following principle refinements apply campus-wide when considering new construction, interior renovations, and

assignment or reassignment of space within new and existing buildings. All such projects must meet applicable Plan principles and patterns whether or not they are subject to Campus Planning Committee review.⁹ Campus Planning and Facilities Management coordinate all interior renovations. (See CPFM description on page 24.)

Space Allocation

Consistent with the university's model of faculty governance, it is the university's practice to make decisions about the assignment of existing space at the lowest administrative level possible. Traditionally the assignment of space occurs within each department. Departments in need of space appeal to their deans or vice presidents, who may assign spaces within the units reporting to them.

For unmet needs, a dean may make a request to the university's Space Advisory Group.

- (a) In general terms, the Space Advisory Group is charged with advising the Provost regarding the assignment of new space that becomes available in existing facilities, receiving space requests from deans and vice presidents, adjudicating disputes over space, and recommending to the appropriate university body principles related to the governing of space. Space allocation shall comply with Plan principles and patterns.
- (b) The university's Committee for Academic Infrastructure, in consultation with CPFM, has primary responsibility for the oversight of general-pool classrooms on the campus, including their design, assignment, and renovations.

⁹ The Campus Planning Committee is not involved in space allocation or interior alterations.

- (c) Spaces do not work properly if they are either overcrowded or under-used. Space proposed for allocation to various functions must always be justified on the basis of demonstrated need.
- (d) In the absence of exceptional circumstances, space-equity issues shall not be resolved by reducing all affected units to the lowest common denominator.

Walking Circles: Instructional Core

Map 6 on the following page identifies the general dimensions of the instructional core through the use of walking circles, the areas that can be traversed within the ten minutes allowed between class changes (a seven-minute walk). Some fixed features, such as Franklin Boulevard, provide barriers to pedestrian travel and need to be accounted for when interpreting walking circles.

- (a) To the maximum extent possible locate instructional facilities scheduled in accordance with the university's fifty-minute daily time schedule within an instructional core that can be traversed within the ten minutes allowed between class changes.
- (b) Except in unusual circumstances the priority for space in facilities situated within the instructional core should be given to programs and activities that either are affected directly by the university's fifty-minute daily time schedule or can function satisfactorily only in proximity to major instructional spaces.
- (c) To maximize future opportunities for concentrating instructional activities within the instructional core, to the greatest extent possible locate new (or relocate existing) programs, activities, and offices on the periphery of the instructional core if they can function satisfactorily without proximity to major instructional spaces.

Flexible and Compatible Use

- (a) Site buildings and program spaces so they provide opportunities for facility expansion and adaptation that will allow for future program growth.
- (b) To the extent possible locate program components in adjacent or reasonably proximate facilities. The intent of this principle is to facilitate the administration and management of resources available to program units; to provide more effectively for informal interaction among faculty, staff, and students; and to assist in the development of cohesive communities of intellectual interest.
- (c) The development and dissemination of knowledge in a complex society often involve the interaction of a number of disciplinary interests. Evaluate opportunities for establishing or enhancing interactions among related disciplines and activities in the process of siting new or expanded facilities.
- (d) Some activities that are essential ingredients of established programs have characteristics that render them incompatible with other activities even within the same community of interest. Kilns, foundries, machine shops, and heavy nighttime occupancies are examples. Locate activities of this sort in such a way as to minimize the resulting conflicts.
- (e) University principle encourages interaction that enhances the free and open exchange of ideas characteristic of a university. To this end the university recognizes the importance of providing some place that can establish an identity for each department and contribute to the coalescence of communities of interest.

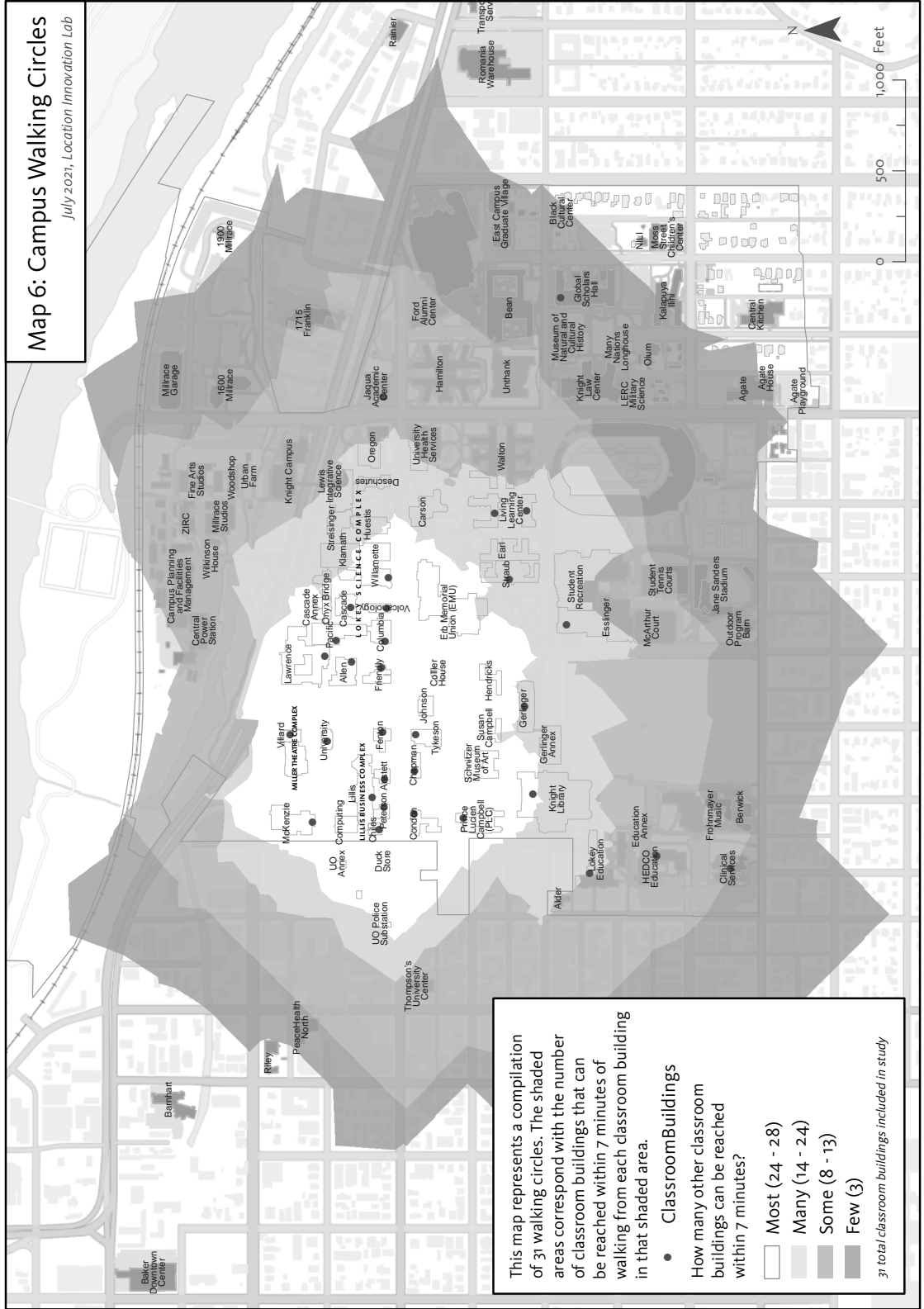

Map 6: Walking Circles

NOTE: These walking circles are a general representation of the distance a student can travel within the ten-minute class break. It assumes 7 minutes of walking time at a walking speed of 3 miles per hour. This data is not exact; it is meant to be a reference tool to help assess the location of the instructional core. Refer to Appendix L for other renditions of walking circles.

- (f) Within buildings, situate major pedestrian destinations, such as classrooms and departmental offices, so that adjacent activities are not unnecessarily disrupted by pedestrian traffic. For example, locate large lecture halls on the ground floor of multi-storied buildings; if necessary, locate smaller classrooms, seminar rooms, and departmental offices adjacent to stair towers or elevators on upper levels.

- (a) Consider the use of the open space when siting buildings and trees, taking care to provide sunny, outdoor spaces for formal class meetings and informal group meetings and activities.

- (b) Outdoor classrooms used as a part of curricular offerings are identified on the diagram below. These open spaces should not be thought of as potential building sites without adequate provisions being included for the replacement of these activities in equivalent spaces. Consideration should also be given to other open spaces that are not part of curricular offerings but serve as “outdoor classrooms.”

Outdoor Classrooms

Many campus open spaces serve as vital classrooms (see diagram below). These functions require open, sunny spaces (for example, sports fields, marching-band practice areas, the Urban Farm, and informal, outdoor meeting spaces).

PRINCIPLE 4



Diagram of Outdoor Classrooms (used for curricular offerings)

PRINCIPLE 5



REPLACEMENT OF DISPLACED USES

PRINCIPLE 5: REPLACEMENT OF DISPLACED USES



Principle

All university uses are important to the university. A new use must not benefit at the expense of an existing use.

All plans for new construction (buildings or remodeling projects) shall keep existing uses intact by developing and funding plans for their replacement as described below.

Pattern Summary

(Refer to “Principle 11: Patterns” on page 91 for the complete pattern text.)

- Existing Uses/Replacement

Principle Refinements

- Sufficient funds for accommodating the required replacement shall be included in the budget for the proposed project unless the president specifically agrees in advance to the contrary or unless provisions for these replacement uses are included in a separately authorized project.

Note: If it has been verified that a use is no longer needed by the affected department, replacement is not required.

- In the case of replacing vehicle parking, consideration shall be given to the location of replacement facilities. The replacement spaces should be sited to serve the same general area as the spaces being replaced.
- When considering the location for displaced uses, the lowest-cost option may not be the final solution. All reasonable efforts will be made to find solutions that

result in the best possible outcome for the campus as a whole. Funding from other university sources may be sought to put in place the optimum solution. This is especially true for best-case solutions in which one displaced use in turn displaces another existing use. The cost of these secondary replacements may not be assigned to the project causing the initial displacement if other funding can be found. Resolution of funding for projects that create multiple replacement issues is primarily the responsibility of the vice president(s) to which the units report.

PRINCIPLE 6



MAINTENANCE AND BUILDING SERVICE

PRINCIPLE 6: MAINTENANCE AND BUILDING SERVICE



Principle

The university was established over 143 years ago and is likely to continue far into the future. Its continued viability depends on the creation of a campus that is long-lasting, easily maintained, and easily serviced.

The university's campus and facilities shall be designed to meet long-term university needs and to be efficiently maintained and operated in accordance with the principle refinements below.

Pattern Summary

(Refer to "Principle 11: Patterns" on page 91 for the complete pattern text.)

- Enough Storage
- **Flexibility and Longevity**
- Hierarchy of Streets
- Materials and Operations
- Shielded Parking and Service Areas
- **Sustainable Development**

Principle Refinements

The following principle refinements apply campus-wide when considering new construction and renovations.

Campus Planning and Facilities Management (CPFM) coordinates building and landscape repair and maintenance projects. (See CPFM description on page 24 and refer to the *Campus Design Standards*.) All such projects must meet applicable Plan principles and patterns whether or not they are subject to Campus Planning Committee review.¹⁰

Maintenance

- (a) Construct new buildings and remodel existing space with high-quality, durable materials and finishes that require a low level of maintenance, and employ construction methods that minimize the need for frequent maintenance by specialized personnel.
- (b) When use of materials or methods requiring a greater level of maintenance is proposed, their selection must be justified in terms of (1) the nature and intensity of the intended use; (2) the context of the building or space with regard to the site or its location within the building; and (3) the relative cost of the higher maintenance requirement over the expected useful lifetime of the building. Consult Facilities Services during this evaluation.
- (c) To the maximum extent possible, select fixtures, hardware, and other consumable materials for installation in university buildings that avoid the need to maintain an extensive inventory of parts. To the extent practicable, use materials that are compatible with existing materials.

¹⁰ The Campus Planning Committee is not involved in building and landscape maintenance and repair projects.

Building Service

- (a) For each campus building or building complex, establish a designated building service area. Each service area should provide facilities for loading and package delivery, garbage and trash collection, recycling, and parking for maintenance and service vehicles. (Refer to diagram below.)
- (b) Integrate the location and design of service areas into the building and landscape design so they are not detrimental to the campus aesthetic. Also refer to the principle refinement addressing landscape screening on page 45.

PRINCIPLE 6



Diagram of Designated Building Service Areas

- Primary Service Area
- UO Parking and Owned Streets
- Campus Boundary

Campus Utilities and Infrastructure

The University of Oregon is served by a variety of utilities that are essential to campus operations. The university's central plant produces steam for heat, chilled water for cooling, and standby power for emergency operations. The university also maintains its own communications systems (including telephone, data, and wireless data), life-safety systems (consisting of a series of emergency call boxes across the campus), and security/access systems for monitoring and managing the use of the buildings and some exterior campus spaces.

A system of tunnels connects on-campus buildings to the central plant north of the Millrace. This tunnel system represents a significant capital expenditure and ensures ease of distribution and maintenance of the services it contains.

The following utilities are distributed through the tunnel system:

- Steam
- Electricity
- Chilled Water
- Communications (includes telephone and data)
- Life safety and security/access

The following utilities are buried on the campus:

- Water
- Sanitary Sewer
- Storm Sewer
- Natural Gas

- (a) All plans adopted for individual building projects shall include an assessment of utility systems and other infrastructure improvements required to support the project. Unless the president specifically agrees to the contrary in advance or unless provisions for these improvements are included in a separately authorized project, sufficient funds for effecting the required infrastructure improvements shall be included in the budget for the proposed project.
- (b) Major projects should include the cost of extending the tunnel system in the calculation of their infrastructure and utility needs.

- (c) New utility distribution lines for utilities currently within tunnels (see list above) shall be located within tunnels. Other utilities not currently in tunnels can be buried.
- (d) Generally, accessory equipment such as transformer vaults are to be buried or located inside buildings to eliminate clutter, preserve the campus character, and prevent equipment damage. HVAC equipment may be located on roofs if it is not in public view.

The Campus Planning Committee may recommend exceptions to this general rule when no safe or practical means of meeting this requirement exists. A plan that contemplates locating accessory equipment partially or wholly above ground is to be reviewed by the Campus Planning Committee. Facilities and equipment so located are to be secured and screened in a manner that minimizes both hazards to personal safety and adverse visual impact. (Refer to the separate *Telecommunications Facilities Guidelines*.)

- (e) To the extent practicable and consistent with other principles, utility systems and system components are to be compatible with university systems and system components.
- (f) All utilities systems must be designed for flexibility and change and installed for ease of access for maintenance and repair.
- (g) Consider opportunities to improve campus-wide utility systems in consultation with Facilities Services and tie into building projects when possible.
- (h) Selection and installation of telephone/data cable equipment will be coordinated through the Telecommunications Services Office of the Department of Business Affairs. Refer to separate *Telecommunications Facilities Guidelines*.

PRINCIPLE 7



ARCHITECTURAL STYLE AND HISTORIC PRESERVATION

PRINCIPLE 7: ARCHITECTURAL STYLE AND HISTORIC PRESERVATION



Principle

The continuity and quality of the university's campus environment are materially affected by the character and architectural style of the buildings. Furthermore, the university's historic buildings and landscapes, which are important defining features of the campus, are artifacts of the cultural heritage of the community, the state, and the nation.

To preserve the overall visual continuity and quality of the campus and as a commitment to the preservation and rehabilitation of identified historic resources, all construction projects shall follow the principle refinements below.

Pattern Summary

(Refer to "Principle 11: Patterns" on page 91 for the complete pattern text.)

- Arcades
- **Architectural Style**
- Building Character and Campus Context
- Building Complex
- **Connected Buildings**
- Family of Entrances
- Four-story Limit
- **Future Expansion**
- Good Neighbor
- Historic Landscapes
- **Main Building Entrance**
- **Operable Windows**
- Quadrangles and the Historic Core
- **Site Repair**
- **Sustainable Development**
- **Wholeness of Project**
- **Wings of Light**

Principle Refinements

Architectural Style

- (a) The design of new buildings and additions shall be compatible and harmonious with the design, orientation, and scale of adjacent buildings, though they need not (and in some cases should not) mimic them.
- (b) In order to create a cohesive campus, new buildings and additions should be responsive to the overall campus character and reflect the materials (e.g., brick) and composition of the Lawrence-era buildings. Emphasis should be placed on creating high-quality, human-scaled, and carefully detailed buildings. Address the campus characteristics described on the following page.



Streisinger Courtyard

Campus Character:



Building Meets the Sky - Complex rooflines draw your eye upwards.



Composition - Buildings should be vertically composed of three parts: top, middle, and bottom. Provide distinction through the use of horizontal lines, such as banding, use of different materials, or variation in patterns and textures.



Main Building Entrance - Provide a clear sense of where to go, how to enter the building; a feeling of arrival, building presence, and weather protection.



Secondary Entrances - These are not as bold as a main entrance, but still easy to locate and with visual interest.



Rhythm of Windows - Repetition of windows break up the scale of the facade (e.g., openings separated by columns or other vertical elements or recessed windows). As a general (but not absolute) rule, avoid large, blank facades, large areas of glazing, or unbroken, horizontally oriented windows (ribbon windows).



Operable Windows and Window Details

- Allow fresh air and the ability to adjust personal environment. Window details can include change in material with banding, brick patterns, type and color of frame.

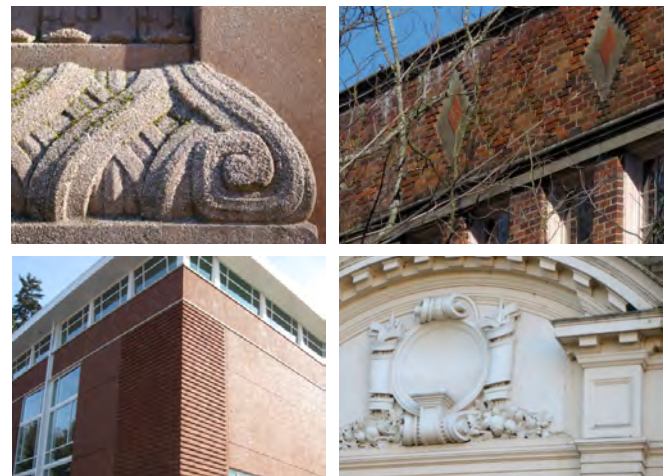

Details - Contribute to the richness of the campus character by giving each building a sense of individuality. Humanize buildings and integrate art.

Historic Preservation

- (a) When altering buildings and landscapes listed in the National Register of Historic Places or as a City Landmark, projects must follow the *Secretary of the Interior's Standards for Rehabilitation and Guidelines for Rehabilitating Historic Buildings*. (Refer to Appendix G for a copy of the standards.)
- (b) When altering interior or exterior resources that are listed or eligible to be listed in the National Register of Historic Places, the university, through Campus Planning and Facilities Management, will consult with the State Historic Preservation Office as appropriate. (Refer to Appendix H for a description of historic resources.)
- (c) When federal funds are used, projects must comply with the federal historic review process (Code of Federal Regulations, Section 106).

Historic Landscapes

These policy refinements address processes for identifying and documenting historic landscapes and provide a framework for making decisions about preferred preservation actions and future development. Refer to the Campus Heritage Landscape Plan, section “1.0 Landscape Preservation Guidelines and Description of Historic Resources” for further definition and a description of treatment approaches.

- (a) Protect and steward the campus's historic landscapes in the context of an evolving university. (Refer to Appendix H on page 180 for a description of historic landscapes.)
- (b) Identify, evaluate, and consider preservation treatment for all potential historic landscapes—designated open spaces and others.
- (c) Develop preservation treatment plans for open spaces determined to be historic.
- (d) Select treatment approaches based upon significance, integrity, and contemporary goals for the space.



Collier House (City Landmark)



Jordan Schnitzer Museum of Art (National Register)



Villard Hall (National Landmark)

- (e) Manage and maintain historic landscapes.
- (f) Balance preservation and other contemporary needs of the university and region.
- (g) Integrate historic landscape characteristics into new elements and areas.
- (h) Document cultural landscape design interventions to leave a clear record of preservation and new design actions that will assist future preservation planning.
- (i) Communicate and educate about the historic qualities of the campus landscape so they become part of the values, culture, and intellectual resource of the university.
- (j) Integrate historic preservation goals into other related *Campus Plan* principles and subject-specific campus planning and maintenance documents.



University Hall Walk Axis, circa 1896 (National Landmark)



Dads' Gates (National Register)



Memorial Quad, circa 1945 (National Register)

PRINCIPLE 8



UNIVERSAL ACCESS

PRINCIPLE 8: UNIVERSAL ACCESS



Principle

In addition to complying with applicable federal and state requirements, the university is committed to making all new facilities welcoming and accessible to all users without discriminating on the basis of ability. This inclusive environment enables all users to participate equally in the university's programs, activities, and services.

To ensure access for all members of its community, all construction projects shall follow the principle refinements below.

Pattern Summary

(Refer to "Principle 11: Patterns" on page 91 for the complete pattern text.)

- **Universal Access**
- **Welcoming to All**

Principle Refinements

- (a) The built environment, including but not limited to buildings, outdoor areas, signs, furniture, amplification systems, alarms, and other features and facilities, shall be designed and constructed to be welcoming to all and conveniently usable within the fullest range of human need. Main entrances, offices, classrooms, laboratories, all other assignable spaces, restrooms, and general circulation spaces shall be inclusively accessible and usable for the entire population. Exceptions to this principle shall be made only in consultation and concurrence with the Disabilities Issues Administrative Council.
- (b) Design of modifications to existing facilities must be guided by the Universal Access pattern and result in fully

accessible spaces to the greatest extent feasible. Consideration also should be given to the possibility of extending a project to include other parts of the facility in order to improve the accessibility of the affected program or building. Projects that substantially renovate entire buildings or floors of buildings or sites are expected to result in a continuous barrier-free environment and not leave patches or islands of barriers.

- (c) When a program is created or relocated, the existing degree of accessibility shall not be diminished and, to the greatest extent possible, should be improved. Plans for relocation and related modification shall be reviewed by Campus Planning and Facilities Management in consultation with the Disabilities Issues Administrative Council as needed.
- (d) Major capital construction projects, including new construction and renovation that could affect the usability of a site or building, shall be reviewed. This review should occur near the end of the schematic design phase of each project.



EMU Entrance



Jordan Schnitzer Museum of Art
Accessible Entrance

PRINCIPLE 9



TRANSPORTATION

PRINCIPLE 9: TRANSPORTATION



Principle

Carefully addressing transportation needs is vital to creating a cohesive, functional campus. A complete transportation principle includes coordinating transportation efforts with the larger community.

To ensure the safe, efficient, and affordable transportation needs of the campus community, all construction projects shall follow the principle refinements below.

Pattern Summary

(Refer to “Principle 11: Patterns” on page 91 for the complete pattern text.)

- Bike Paths, Racks, and Lockers
- Hierarchy of Streets
- **Local Transport Area**
- Looped Local Roads
- Main Gateways
- Path Shape
- Paths and Goals
- Pedestrian Pathways
- Peripheral Parking
- Promenade
- Road Crossings
- Shielded Parking and Service Areas
- Small Parking Lots in Campus Core
- Spillover Parking
- **Universal Access**
- University Shape and Diameter

Principle Refinements

Land Use and Transportation

- (a) The central area of campus (between Alder and Kincaid Streets on the west side, 18th Avenue on the south, Agate Street on the east, and Franklin Boulevard on the north) is primarily regarded as a pedestrian and bicycle zone. Unnecessary automobile traffic in that area is discouraged,

and internal campus streets should not serve as throughways.

- (b) The following priorities are established for making transportation-related decisions:

The highest priority is given to:

1. emergency vehicles, followed by:
2. pedestrians and people with disabilities,
3. bicyclists,
4. public transportation,
5. service vehicles,
6. car pools,
7. motorcycles,
8. scooters, **and, lastly,**
9. personal cars.

- (c) The university acknowledges it has assumed responsibility to provide a reasonable level of affordable parking for students, faculty, staff, and visitors while preserving the quality of the campus and adjacent neighborhood environments and encouraging the use of alternative modes of transportation. Thus, the university will continue to pursue programs and projects that both meet the need for affordable automobile parking and encourage alternative forms of transportation, thereby reducing the demand for automobile parking.

- (d) Building projects will comply with the *University of Oregon Bicycle Management Program* and the 1991 *University of Oregon Bicycle Plan*.

Refer to the Campus Design Standards for a description of the approved bike rack designs.

- (e) Activities with a high degree of public interaction will be located in peripheral locations where facilities to accommodate greater concentrations of vehicular traffic can be developed if they are not already in place.
- (f) Activities that depend on frequent delivery service, especially by large trucks, will be located adjacent to major thoroughfares or sited in a way that does not require or encourage truck travel through the central campus.



Knight Library Bike Parking

Community Transportation Coordination

- (a) The university adopts by reference the City of Eugene transportation plans as they pertain to the University of Oregon and adjacent lands. (Refer to Appendix J.)
- (b) The university adopts and reaffirms the concepts adopted as part of the *University of Oregon Long Range Campus Transportation Plan* initially adopted by the Campus Planning Committee in April 1973 and approved by the president in April 1975.
- (c) In accordance with the City of Eugene code provision allowing a fifty-percent reduction in the minimum required off-street parking spaces for university uses, the university must have a Transportation Demand Management (TDM) plan approved by the city demonstrating that the use of alternative modes of transportation will reduce expected vehicle use and parking space demand. The TDM plan will establish benchmarks by which the plan's effectiveness will be monitored annually.



EmX Dads' Gates Station

PRINCIPLE 10



SUSTAINABLE DEVELOPMENT

PRINCIPLE 10: SUSTAINABLE DEVELOPMENT



Principle

The development, repair, maintenance, and operations of the University of Oregon today have an impact on the local environment and the ability of future generations to thrive.

All development, redevelopment, and remodeling on the University of Oregon campus shall incorporate sustainable design principles including existing and future land use, landscaping, building, and transportation plans as described in the principle refinement below.

Pattern Summary

(Refer to “Principle 11: Patterns” on page 91 for the complete pattern text.)

- Bike Paths, Racks, and Lockers
- Campus Trees
- **Flexibility and Longevity**
- **Local Transport Area**
- Materials and Operations
- **Operable Windows**
- Pedestrian Pathways
- Peripheral Parking
- **Quality of Light**
- Road Crossings
- **Site Repair**
- **Sustainable Development**
- **Use Wisely What We Have**
- Tree Places
- Water Quality
- **Wings of Light**

Additional *Campus Tree Plan* Patterns:

- Environmental Mitigation
- Healthy and Vital Tree Canopy
- Long-lived Tree Sites
- Site-specific Conditions
- Tree Replacement Strategies

Principle Refinements

All construction projects shall adhere to the university’s **Oregon Model for Sustainable Development** described on the following pages.

Also refer to the following related principles:

- Principle 2: Open-space Framework (in particular principle refinements addressing wetlands, wildlife habitats, and waterways; the selection of plant materials and the *Campus Tree Plan*), and the Campus Outdoor Lighting Plan.

- Principle 9: Transportation and related patterns.

- Principle 12: Design Area Special Conditions (in particular for areas with wetlands, wildlife habitats, and waterways.

Principles 2 and 12 are particularly relevant to maintaining and enhancing the ecosystems of the campus.



Many Nations Longhouse bioswale and green roof



HEDCO Courtyard, 2009.

University of Oregon Model for Sustainable Development

The University of Oregon Model for Sustainable Development addresses the unique aspects of campus buildings and landscapes by focusing on what matters most: ENERGY, WATER, AND PEOPLE. In addition, the University of Oregon has made a commitment for capital projects to achieve LEED Gold.

This Model focuses on capital projects. It is one of many strategies the university has implemented to achieve its overall sustainability goals.

All capital projects as well as the surrounding landscape improvements within the project boundary shall adhere to the University of Oregon Model for Sustainable Development.

The principle should be reevaluated:

- At each revision to the Oregon Energy Code;
- At the release of each new version of LEED; OR
- No later than five years after the last policy reevaluation.

ENERGY, WATER, AND PEOPLE GOALS

The energy, water, and people goals are applicable to the following capital projects:

1. New buildings, of 10,000 square feet (sf) or more of heated or cooled floor area;
2. Building additions of 10,000 square feet (sf) or more of heated or cooled floor area. Additions must have a clear separation of all systems and spaces;
3. Whole building renovations of 10,000 square feet (sf) or more of heated or cooled floor area, which:
 - i. Upgrade the existing mechanical systems for the entire building; AND
 - ii. Significantly affect at least one of the following energy systems: interior lighting or building envelope.

Projects that do not meet the criteria listed above should strive for excellence in the energy, water and people categories. These projects should make use of the university's documented and proven sustainable design strategies implemented on other capital projects.

ENERGY GOAL: Optimize and Mitigate

The university seeks to optimize the energy efficiency of all new buildings and mitigate any increases in total campus energy use from all capital projects.

All capital projects are required to achieve a state-of-the-art energy performance level—an Advanced Energy Threshold. In addition, the university tracks energy usage and will undertake cost-effective energy-savings measures as opportunities arise with a goal of mitigating increases in total energy use.

ADVANCED ENERGY THRESHOLD (AET)

Capital projects (as defined above) must meet the Advanced Energy Threshold, which is defined as 25% more efficient than the 2014 Oregon Energy Code requirements.

A standard energy modeling method (e.g., those acceptable for LEED documentation) should be used to compare the designed building to a baseline building and demonstrate that the AET is met.

The AET will ramp up to a higher standard over time as recommended by a small council of knowledgeable individuals led by Campus Planning and Facilities Management.

To achieve and go beyond the required AET and to study ways of achieving net zero energy use for the building, projects are encouraged to use an integrative design process.

WATER GOAL: Improved Quality of Stormwater

The university will improve the quality of campus stormwater emitted into the region's waterways by focusing on campus areas that contribute the most to the degradation of water quality—campus streets and parking lots. All capital projects are required to treat the equivalent amount of stormwater runoff as required by city code; however, some of the areas treated will be shifted outside the project site to address relatively low water quality campus areas—streets and parking lots.

All capital projects will treat stormwater runoff from a portion of an existing UO-owned street or parking area instead of treating the equivalent amount of relatively clean, on-site, impervious surfaces, primarily defined as pedestrian surfaces such as sidewalks (especially those that do not drain directly into a stormwater pipe). The same amount of impervious surface will be treated, but the dirtier surfaces will receive greater attention.

For example, if a project site has 1,000 square feet of sidewalks that must be treated, the project would not be required to treat this area; instead, it would be required to fund 1,000 square feet of stormwater treatment for an existing campus street or parking lot.

The cost to treat existing streets and parking areas is determined by establishing an average cost/square foot. The project is not responsible for identifying and implementing the off-site stormwater measures. Funds are deposited into a central fund earmarked for stormwater treatment measures. Facilities Services manages the fund and appropriately implements measures needed to equal the required stormwater treatment from all development projects.

Projects should be designed to accommodate the potential to treat all of their stormwater in the future.

This goal requires coordination with the city (and in some cases may preclude implementation of this Principle).

PEOPLE GOAL: Sustain Campus Habits and Foster Social Equity

The university ensures sustained energy conservation habits. All capital projects are required to develop a plan and implement educational/training opportunities about the building and/or landscape in order to create and sustain a shift in occupant behavior.

All capital projects will fund educational/training opportunities about the building and/or landscape with a goal of shifting occupant behavior to support energy use and other goals. Opportunities will consist of the following:

- Training sessions and distribution of informational materials designed for faculty and staff occupying the new building as well

as for building operations staff during the first two years of occupancy. Training may be in the form of a class or research project.

- An electronic dashboard program that provides real time energy use and other permanent, integrated, educational elements, such as an informational kiosk or a series of plaques, highlighting key sustainable building and landscape strategies with a focus on behavior.

It is expected that implementation of the educational/training components will cost a minimum of \$35,000 (about \$10,000 for the training and distribution of materials and \$25,000 for the permanent features). Smaller buildings or low-occupancy buildings, however, may require a smaller investment.

Foster Social Equity: Social equity is a foundational Principle of sustainability. As the university seeks to ensure equity across all social categories, all capital projects are required to foster and promote social equity and human health. Examples of achieving this goal include:

- Maintaining high levels of indoor environmental quality (IEQ) to benefit the health and comfort of the building's inhabitants;
- Displaying sample sources of a building's construction labor and materials production, extraction and processing;
- Following Principles of universal design to ensure equity in building use and accessibility beyond what is required by code;
- Providing gender inclusive restroom facilities so that all individuals have access to restroom facilities; and
- Providing access to functional, private, safe, and clean lactation rooms across campus.

LEED GOAL: Gold Certification

The LEED goal is applicable to the following capital projects:

1. New buildings of 10,000 square feet (sf) or more of heated or cooled floor area.
2. Building additions of 10,000 square feet (sf) or more of heated or cooled floor area where the added floor area is more than 60% of the resulting total gross square footage; AND
3. Major building renovations of 10,000 square feet (sf) or more of heated or cooled floor area that affect more than 60% of the gross

square footage in the building and include upgrades to mechanical equipment serving the entire building.

Projects that do not meet the criteria listed above should strive for excellence in sustainable design. These projects should make use of the university's documented and proven sustainable design strategies implemented on other capital projects.

All capital projects that meet one of the criteria (1-3) listed above must achieve Leadership in Energy and Environmental Design (LEED) Gold certification. The certification process verifies that the project achieved a nationally recognized sustainability standard (LEED Gold) and demonstrates that the university is committed to sustainable design.

ADJUSTMENTS:

If a highly unique circumstance arises, a project may request an adjustment to a requirement to resolve an unreasonable hardship. For example, specialized building types may be uniquely challenged with meeting the AET.

Adjustments will be reviewed by the Campus Planning Committee as part of the standard project review process. The requester must clearly demonstrate the following:

1. Requested Adjustment: The requested adjustment (e.g., a lower AET or LEED level, or no LEED Certification process) must:
 - be clearly defined,
 - be justified as described in #2 below, and
 - demonstrate that the overall intent of the Model is still met.
2. Reason for the Adjustment: The circumstance must be highly unique and create an unreasonable hardship. Evidence of undue hardship must be thoroughly justified, which, at a minimum, includes a full assessment of building components, energy use, and associated costs that would have been necessary to fully meet the affected requirement.

PRINCIPLE 11

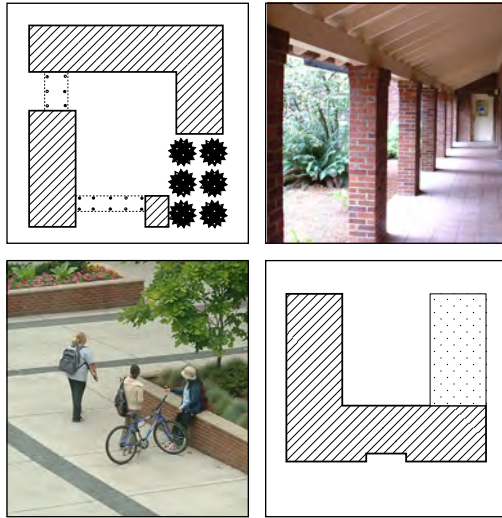

PATTERNS

PRINCIPLE 11: PATTERNS

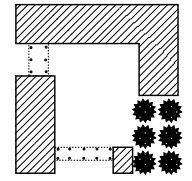

Principle

Patterns establish a means of articulating commonly held values as they pertain to the campus environment and design. Patterns ideally function together as words in a sentence, creating a cohesive whole built on a common design language, the “pattern language.”

To achieve effective and meaningful dialog about important campus design issues, all construction projects shall consider the patterns below.

Patterns

Each pattern shall be considered during project design, as described in this chapter.

Patterns are statements that describe and analyze design issues and suggest ways in which those issues might be resolved.

The term “pattern language” is best known from the book *A Pattern Language*.¹² Its Principle author, Christopher Alexander, helped the University of Oregon develop its planning process in the early 1970s. A pattern is “any general planning principle, which states a clear problem that may occur repeatedly in the environment, states the range of contexts in which this problem will occur, and gives the general features required by all buildings or plans which will solve this problem” (*The Oregon Experiment*, page 177). These patterns ideally function together as words in a sentence, creating a cohesive whole built on a common design language, the “pattern language.”

The process and its constituent components are described more fully in the book *The Oregon Experiment*. The purpose of developing a pattern language was to provide a non-technical vocabulary of design principles that would allow building users to communicate effectively with the planners and designers of those buildings.

The university must maintain a balanced perspective on the physical development of the campus. It must be able to respond quickly to opportunities for facilities improvements as they emerge. It also must employ long-range planning and emphasize the importance of long-term continuity in development decisions. The use of patterns, as opposed to a “fixed image” master plan, helps to achieve this goal. Patterns articulate long-lasting shared traditions and understandings yet adapt well to changing development needs.

Application of Patterns in the Design Process: Project Pattern Lists

- (a) All user groups shall review the Campus-wide Pattern List (page 93) and select patterns with issues relevant to their projects (and add new patterns as appropriate; see (c) below). Every project pattern list must include those patterns highlighted in bold-face type. At the beginning of a project’s design process Campus Planning and Facilities Management will work with the project sponsor to create a draft project pattern list. The Campus Planning Committee, during its review of the project’s process (see “Principle 1: Process and Participation,” page 21), will comment on the appropriateness and completeness of the list of patterns selected.

¹² Christopher Alexander et al., *A Pattern Language* (New York: Oxford UP, 1977).

- (b) Each pattern on the Campus-wide Pattern List shall be considered as the project is designed. If any patterns in bold typeface are not implemented, the reasons for their omission are to be reported to the Campus Planning Committee during its schematic design review. (See "Principle 1: Process and Participation", page 21.)
- (c) As the user group defines the project, the list may grow to include new patterns written to address specific issues the user group wishes the project architect to consider or to include other patterns not previously identified. The list may continue to grow during project design as the result of new or newly added patterns.
- (d) In most cases, literal interpretation of a pattern should be avoided. The pattern is intended to help identify the essence of an issue that needs to be considered and to suggest ways in which the issue might be resolved. In some cases it is possible that although the problem is properly identified, the solution suggested by the pattern may not be appropriate. Such cases call for an alternate means of resolving the issue.

The accompanying graphics are provided for illustrative purposes only. The pattern text takes precedence.

Campus-wide Pattern List: A Pattern Language for the University of Oregon

The following list is arranged roughly from global issues to specific issues.

Highlighted patterns must be considered for every project.

The full text of each pattern, with patterns arranged in alphabetical order, follows this list.

LARGE SCALE CAMPUS

This first set of patterns defines how the campus is formed at the greatest scale and looks at the composition of the entire campus.

Campus Trees
 Good Neighbor
 Historic Landscapes
 Main Gateways
Open-space Framework
 Open University
 Outdoor Classroom
 Promenade
 Quadrangles and the Historic Core
 Student Housing
Sustainable Development
Universal Access
 University Shape and Diameter
Welcoming to All

TRANSPORTATION

This set of patterns defines the transportation systems (including pathways) of the entire campus.

Bike Paths, Racks, and Lockers
 Hierarchy of Streets
Local Transport Area
 Looped Local Roads
 Paths and Goals
 Path Shape
 Pedestrian Pathways
 Peripheral Parking
 Road Crossings
 Shielded Parking and Service Areas
 Small Parking Lots in Campus Core
 Spillover Parking

SITE ARRANGEMENT

This set of patterns informs how buildings should be arranged to become a part of the campus.

Access to Water
 Accessible Green
 Activity Nodes
Building Complex
Connected Buildings
Existing Uses/Replacement
 Family of Entrances
 Local Sports
Main Building Entrance
Positive Outdoor Space
 Public Outdoor Room
Quiet Backs
 Research Ties
 Seat Spots
Site Repair
 Sitting Wall
 Small Public Squares
South Facing Outdoors
 Tree Places
Use Wisely What We Have
 Water Quality

BUILDING DESIGN

This set of patterns informs how each building should be designed.

Arcades
Architectural Style
 Building Character and Campus Context
Building Hearth
 Classroom Distribution
 Enough Storage
 Fabric of Departments
 Faculty-Student Mix
Flexibility and Longevity
Four-story Limit
Future Expansion
 Materials and Operations
 No Signs Needed
 Office Connections
Operable Windows
Organizational Clarity
 Places to Wait
 Pools of Light
 Public Gradient
Quality of Light
Wholeness of Project
Wings of Light

Campus-wide Pattern Descriptions

Highlighted patterns must be considered for every project.

An asterisk (*) identifies patterns that also are principles or principle refinements. They are restated here as patterns to ensure their consideration during the design process. Refer to each principle for exact requirements.

Refer to separate subject plans such as the Campus Tree Plan and the Development Policy for the East Campus Area for additional patterns.



Access to Water

People have a fundamental yearning for bodies of water. Hearing it, being near it, and touching it are things people like to do.

THEREFORE: When possible create water features that allow campus users to listen to and touch water. These could be as simple as standing pools or as dramatic as water falling from a high spot.



Accessible Green

When people work extremely close to large open green areas, they visit them and use them often; but even a fairly short distance will discourage them.

THEREFORE: Provide a green outdoor space, for passive or active use, that is at least 50,000 square feet in area and at least 100 feet across in the narrowest direction, within 600 feet of every on-campus building.

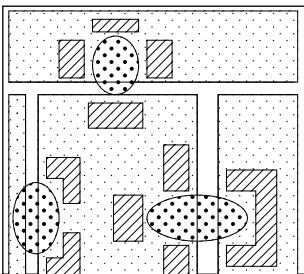

Activity Nodes

When buildings are spread evenly across campus, they do not generate small centers of public life around them. They do nothing to help the various “neighborhoods” on the campus to coalesce.

THEREFORE: When locating buildings, place them in conjunction with other buildings to form small nodes of public life. Create a series of these nodes throughout the university, in contrast to the quiet, private outdoor spaces between them, and knit these nodes together with a network of pedestrian paths.



Arcades

Arcades at the edges of buildings—partly inside and partly outside the building—play a vital role in the way group territory and the society-at-large interact. Our climate is especially suited for sitting or walking outside under cover on a rainy day. South-facing arcades create wonderful micro-climates during most of the year.

THEREFORE: Whenever possible, create arcades along the sides of buildings or between their wings, and open building interiors to these arcades. As possible, knit these arcades together with campus paths so they form a semi-covered system of paths throughout the campus.

Architectural Style* [See “Principle 7: Architectural Style and Historic Preservation” on page 71 for requirements.]

The continuity of the university’s campus environment is materially affected by the character and architectural styles of the buildings that are constructed.

THEREFORE: Make the design of new buildings compatible and harmonious with the design of adjacent buildings (on and off campus), though they need not (and in some cases should not) mimic them.



Bike Paths, Racks, and Lockers* [See “Principle 9: Transportation” on page 81 for requirements.]

Bikes are cheap, healthy, good for the environment, and a critical component to the university’s transportation system. They are threatened by cars on streets, they can be a threat to pedestrians on pedestrian paths, and they need secure, convenient, and attractive storage.

THEREFORE: Consider how each development or building can contribute to the campus-wide system of paths, racks, and lockers. Pay particular attention to the location of racks and lockers to ensure their appropriate adjacency to the path system and their popularity.



Building Character and Campus Context

Individuals develop impressions about a building immediately upon seeing it, and these impressions affect their perception of the building’s occupants and their endeavors. The image of a building is defined also by its surrounding campus fabric and vice versa.

THEREFORE: Ensure that the exterior character clearly communicates the unique nature of the facility while respecting and enhancing the context of the surrounding campus. The building should attract students and encourage them to use the resources and services offered within.



Building Complex

The human scale vanishes in enormous buildings. People who use them stop identifying the staff who work there as personalities, and the staff feel like small cogs in a greater machine.

THEREFORE: To maintain human scale in campus buildings, make them small, perhaps no larger than 100,000 gross square feet (with some notable exceptions such as libraries and recreation facilities) and not more than three or four stories high. If more space is needed, the buildings should be conceived as a collection connected by arcades or bridges defining and embracing outdoor spaces.

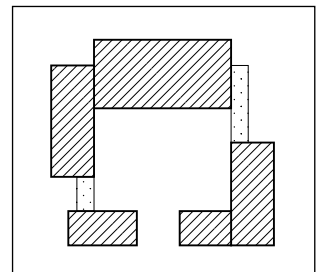

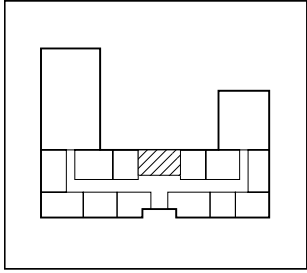

Building Hearth

When a building is just a collection of rooms without a focus, there is little chance for a sense of community to develop, and the possibility of an open exchange of ideas diminishes.

THEREFORE: Create a social hearth for every building. Place the hearth at the building’s perceived center of gravity and beside a path that everyone uses. Within the hearth provide space for a lounge, mail, coffee, supplies, student information, etc. Additional hearths for departments may be appropriate as well once the building hearth is accommodated.

Campus Trees

The UO campus is an arboretum and a tree identification classroom. Not only are there many unusual trees, memorial trees, and otherwise special trees, but trees also play an important part in the formation of open spaces (for example, by creating edges). Building projects often are considered for sites that are occupied by trees, setting up a conflict between programmatic and aesthetic needs.



THEREFORE: Whenever possible, build in ways that preserve or relocate trees. If any trees must be removed, follow the requirements of the university’s *Campus Tree Plan*.

Classroom Distribution

Intimate seminars for ten students do not work well in huge classrooms; and classrooms beyond a seven-minute walking circle cannot be reached on foot during the ten minutes between classes.



THEREFORE: Construct classrooms so that each type (classified by number of seats) is distributed among the total classroom pool according to the following percentages:

Classroom type by numbers of seats	Percentage of classrooms of this type
0 - 15	3%
16 - 30	30%
31 - 60	39%
61 - 90	11%
91 - 150	12%
151 - 300	4%
300 and up	1%

Reserve the center part of campus for classrooms so students and faculty can walk easily to their next classes.

Connected Buildings

Isolated buildings can be symptoms of a disconnected campus community.

THEREFORE: Consider connecting new buildings to existing buildings wherever possible. Try to form new buildings as continuations of older buildings and, in so doing, use the arrangement of the buildings to make pleasant outdoor spaces.

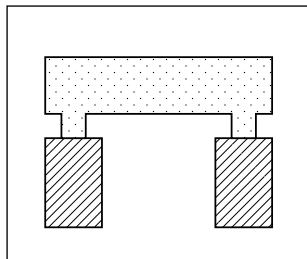

Enough Storage

Lack of storage space can turn staff work spaces into storage areas and cause staff to waste valuable time locating and retrieving stored items.

THEREFORE: Provide space in each program for storage of equipment and materials, and provide central storage for shared items. Centralized storage, as well as storage for separate programs, may be provided either as shared or as discrete spaces depending on specific program needs.



Existing Uses/Replacement* [See “Principle 5: Replacement of Displaced Uses” on page 61 for requirements.]

All university uses are important to the university. A new use must not benefit at the expense of an existing use.

THEREFORE: All plans for new development (buildings, landscape, or remodeling projects) shall keep existing uses intact by developing plans and identifying funding for their replacement.



Fabric of Departments

Overemphasis on the individuality of departments helps to fragment knowledge by keeping it in watertight compartments. Yet each department requires its own identity.

THEREFORE: Give each department a clearly identified home base, but spread the parts of the department within a radius of about 500 feet so they interlock with parts of other departments. No one of these parts should contain less than five faculty offices.

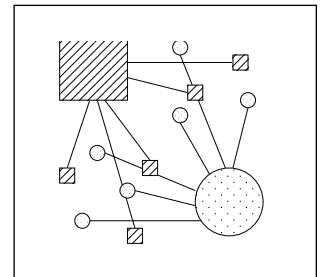

Faculty-Student Mix

Students and faculty can benefit most from each other if they are able to develop mutual respect and common interests within small groups. Learning and research cannot flourish without the sustained, informal contacts that occur within such groups.

THEREFORE: Cluster student workplaces around faculty offices. Give each cluster a common entrance and a common area which contains seats, books, journals, microwave, seminar table, and the like.

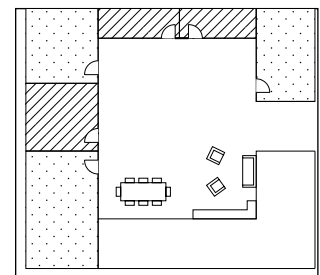

Family of Entrances

When people enter a complex of buildings, they may experience confusion unless the whole collection of entries is laid out so they can see the entrance to the place they are going.

THEREFORE: Lay out the entrances to form a family. This means:

1. They form a group, are visible together, and each is visible from all the others.
2. They are all clearly recognizable as entrances.

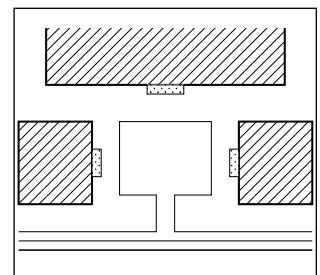

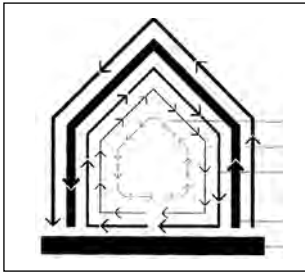
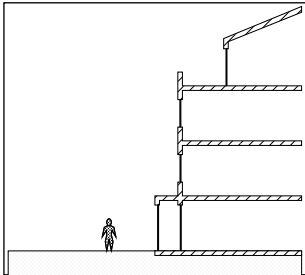

Image from *How Buildings Learn* by Stewart Brand (1994), page 13.

Flexibility and Longevity

Even today's best building will eventually be disliked if it is poorly planned for the future or poorly built. If it can't adapt to programmatic change, it will either frustrate its users or be demolished.

THEREFORE: Provide flexibility through several concepts. First, make the least flexible systems, such as structure and mechanical systems, long lasting and carefully planned for general usefulness independent of programmatic need. Second, avoid designing space that is over tailored to a specific use. For example, make sure that a computer lab may have a future life as a classroom, a lounge, or a learning center. Third, make interior partitions relatively "soft" to allow future removal without major disruption. For example, put electrical panels, major ducts, and electrical risers on corridor or exterior walls. Finally, provide spare capacity in critical building systems such as electrical power, air handling, and fire alarms so that future intensification of use can occur without total revision of existing systems.



Four-story Limit

An important aspect of the campus's beauty is access to sunlight, views of the sky, and human scale.

THEREFORE: Keep the majority of buildings four stories high or less. It is possible that a few buildings may exceed this limit, but strong consideration must be given to the resultant shadows and skyline to ensure the beauty of the campus and the importance of the individual.

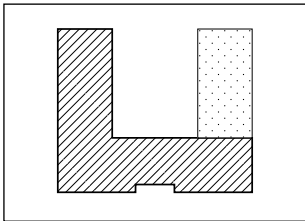

Future Expansion

Buildings inevitably change and expand over time to adapt to changing user needs.

THEREFORE: Consider the possibility of future expansion and change when designing a new building or addition.

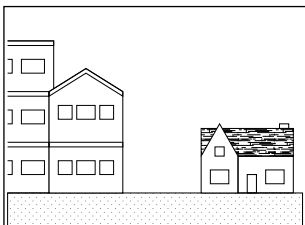

Good Neighbor

It's easy to be so focused on making campus projects as wonderful as possible for their users that we ignore their impacts on our neighbors.

THEREFORE: Consider each project's impacts on neighbors and community. For example, what will the building look like from outside the campus boundaries? What parking impacts may spill over into other areas?

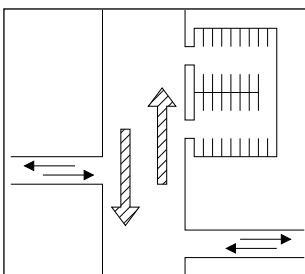

Hierarchy of Streets

Campus traffic may seek short cuts through residential areas near the campus if more appropriate alternatives don't exist.

THEREFORE: Discourage auto traffic on streets that do not connect to arterials or neighborhood collectors, and encourage traffic on streets that do.

Historic Landscapes [See “Principle 7: Architectural Style and Historic Preservation” on page 71 for requirements.]

The campus landscape is a record of its time, place, and use and is a repository of significant local and state history. When characteristic features of a historic landscape are lost, the integrity and ability of the landscape to tell this story is destroyed and the campus context is diminished.

Therefore: Protect and steward historic landscapes in the context of an evolving university. Select treatment approaches (preservation, rehabilitation, restoration, and continuation) based upon historic significance, integrity, and contemporary goals for the space. As the campus expands, consider integrating historic landscape characteristics into new areas to enhance a sense of campus-wide order and cohesiveness. Refer to the Campus Heritage Landscape Plan.



Local Sports

Students cannot get a good education in a place that runs like a factory with a hectic work pace and without the chance for a relaxing physical diversion.

THEREFORE: Arrange opportunities for recreation on campus so that every point is within 600 feet of a place designed for sports and leisure—a swimming pool, gym, basketball hoop, tennis courts, open field, etc.



Local Transport Area

The impact of the car on social life is devastating: it keeps us off the streets and far away from one another. The first step in bringing the car under control is to stop using it for local trips.

THEREFORE: Embed the university in a local transport area one to two miles in diameter. Except for very special cases, encourage local trips within this area to be made on foot, bikes, or scooters. Adapt paths and roads to these modes of travel, and keep the streets slow and circuitous. At the edge of the local transport area create access to transit and car-storage areas.



Looped Local Roads

Through traffic destroys the tranquility and the safety of pedestrian areas. This is especially true in university districts, where the creation of quiet precincts is crucial to scholarship.

THEREFORE: To bring the traffic and the pedestrian world into the right balance, make the local roads that serve the area form a system of loops or cul-de-sac, so that through traffic is impossible.

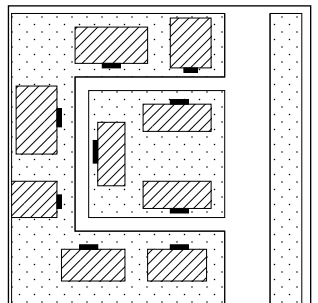

Main Building Entrance

Placing the main entrance(s) is perhaps the single most important step taken during the evolution of a building plan.

THEREFORE: Place the main entrance(s) of the building at a point immediately visible from the main avenues of approach, and give it a bold shape in the front of the building.

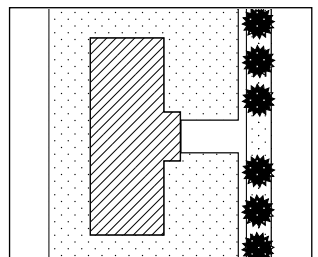



Main Gateways

Any part of an area—large or small—that is to be identified by its users as a precinct of some kind will be reinforced or made more distinct and more vivid if the paths crossing its boundary are marked by gateways.

THEREFORE: Mark every campus boundary that has important meaning with great welcoming gateways where the major entering paths cross the boundary.



Materials and Operations

Poorly selected materials, inappropriate energy strategies, and complex facilities designs all can contribute to high operating costs. Maintenance not only is a major component of the operating budget but also is a health issue.

THEREFORE: Designers should select materials that are easy to maintain and healthy, creating buildings that are energy efficient and easy to add on to or modify later.



No Signs Needed

Some buildings seem to have been planned to need signs so that people can find their way. Alternatively, a building can be designed to be self guiding, making it as easy as possible to negotiate through.

THEREFORE: Plan buildings to be as self guiding as possible so the signs are used to supplement good planning rather than to overcome bad planning.

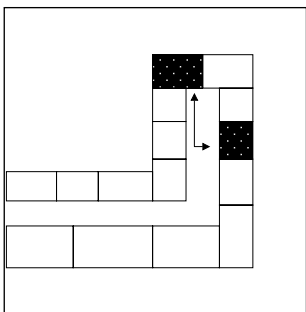

Office Connections

If two parts of an institute, center, department, or administrative unit are too far apart, people will not move between them as often as they need to; if the parts are more than one floor apart, there will be almost no communication between them.

THEREFORE: To establish distances between offices within the same organization, calculate the number of trips per day made between each of the two offices and ensure that those with frequent contact are located on the same floor within a reasonable walking distance of each other.

Open-space Framework* [See “Designated Open Spaces” in “Principle 2: Open-space Framework” on page 37 for requirements.]

The University of Oregon campus is organized as a system of quadrangles, malls, pathways, and other open spaces and their landscapes. This organizational framework not only functions well, but also serves as a physical representation of the university’s heritage.

THEREFORE: Build in ways that improve the existing open-space framework and extend it as possible.



Open University

When a university campus is separated from the town by a hard boundary, students and townspeople tend to be isolated from each other; in a subtle way the university takes on the character of a glorified high school.

THEREFORE: Ensure that the campus edges are soft and the gateways marking the boundary between university and town are welcoming and inviting to townspeople rather than shunning. For students, make easy connections to the town so they are encouraged to visit the town often. Refer to “Principle 2: Open-space Framework” on page 37 for more on edges.



Operable Windows

People who work for several hours each day in confined spaces such as offices benefit from access to fresh outside air. Current research indicates that such access also improves educational achievement. Additionally, energy savings accrue when users are able to adjust their own environments by opening windows and letting in outside air.

THEREFORE: In the absence of compelling reasons to the contrary, all exterior windows of university buildings must be able to be opened wholly or in part.



Organizational Clarity

Buildings whose organization is difficult to understand are difficult to use. First-time visitors are easily confused, and long-time users get frustrated.

THEREFORE: Create a clear organization and circulation scheme for the building. Ideally each floor would broadly resemble the others. Provide cues through visible landmarks, interior day lighting, and interior vistas that clearly convey how the building’s parts relate and join one another.

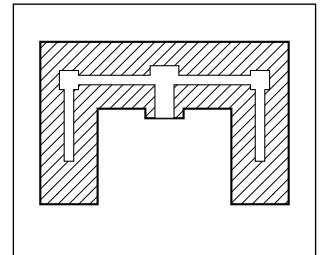

Outdoor Classroom

Many campus open spaces serve as vital “classrooms.” Many outdoor-classroom functions require open, sunny spaces (e.g., sports fields, marching band practice areas, the urban farm, and informal outdoor spaces for teaching classes).

THEREFORE: Preserve the open, sunny spaces required for outdoor classrooms. Always consider the use of the open space when selecting and placing trees. This may mean that it is not always possible to replant the total lost tree canopy caused by development projects.



Path Shape

Pathways should be inviting enough to be more than a means of travel. Generally, pathways connect large open spaces or heavily used destinations on the campus. Many of them are former city streets around which the campus has grown or are alongside and parallel to former streets.

THEREFORE: Make pathways places to linger rather than just connectors to pass through by creating wide spots for benches and low walls for seating. Remake old city streets into pathways that emphasize their pedestrian nature and de-emphasize their former car nature.

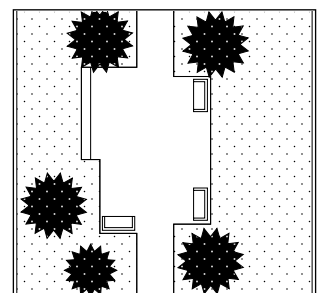

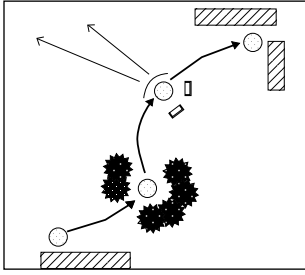

Paths and Goals

The layout of paths will seem right and comfortable only when it is compatible with walking (and walking is far more subtle than one might imagine).

THEREFORE: To lay out paths, first place goals at natural points of interest. Then connect the goals to one another to form the paths. The paths may be straight or gently curving between goals; their paving should swell around the goal.



Pedestrian Pathways* [See “Pathways” in “Principle 2: Open-space Framework” on page 38 for requirements.]

Pedestrian travel should be encouraged as an essential component of the campus experience. Pedestrian activity creates an environment that encourages interaction and discourages automobile use.

THEREFORE: Promote walking by creating a system of interconnected pathways as an alternative to street sidewalks. This pathway system will be considered part of the campus open-space framework.

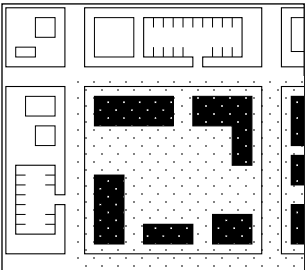

Peripheral Parking

As the university grows, parking may threaten to overwhelm the campus environment. But if parking areas are too far away, teaching and learning may suffer.

THEREFORE: Distribute parking along the edges of the campus (see “Local Transport Area” pattern) so that people can walk from their cars to their destinations in a reasonable amount of time without having to cross the width of the entire campus.

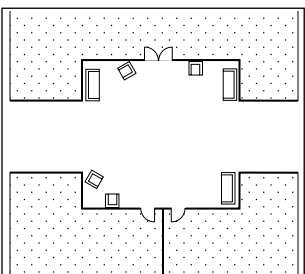

Places to Wait

Students often have to wait outside an office for an appointment or outside a classroom when the preceding class gets out late. Also, after class students and teachers often wish to continue conversations begun in class, but they have no place to do so.

THEREFORE: Provide generous circulation space near classroom entrances and offices, with benches or other seating, but not so much as to attract large groups that might make excessive noise.

Pools of Light

Uniform illumination—the conventional lighting solution—serves no useful purpose whatsoever. In fact, it destroys the social nature of space and makes people feel disoriented and unbounded.

THEREFORE: Place lights to form individual pools of light, which encompass chairs and tables like bubbles, to reinforce the social character of the spaces they form. Remember that you can’t have pools of light without the darker places in between.

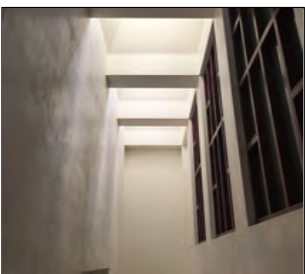

Positive Outdoor Space

In general, outdoor spaces that are merely “left over” between buildings will not be used.

THEREFORE: Always place buildings so that they embrace the outdoor spaces they form. Design the landscape so that some sides of the outdoor space are defined by buildings and some sides by arcades, trees, or low walls. Be sure to leave entrances to the outdoor “room” at several points so people can pass freely through the space and travel to other connecting outdoor spaces.

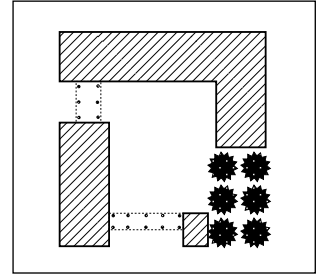

Promenade

Each subculture needs a center for its public life, a place where people can go to see others and to be seen.

THEREFORE: Encourage the formation of promenades through the heart of the campus, linking main activity nodes and placed centrally so that each point in the campus is within ten minutes’ walk of a promenade.



Public Gradient

Unless the spaces in a building are arranged in a sequence that corresponds to their degree of privateness, the visits made by strangers or guests may be a little awkward.

THEREFORE: Lay out the spaces in a building to create a sequence that begins with the most public parts of the building near the entrance, then leads into the slightly more private areas, and finally leads to the most private domains.

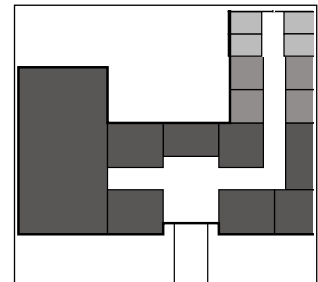

Public Outdoor Room

Only a very few spots exist along the streets of modern towns and neighborhoods where people can hang out comfortably for hours at a time.

THEREFORE: On the campus, make a piece of the common land into an outdoor room—a partly enclosed place, without walls, but with some roof, columns, places to sit, and perhaps with a trellis. Place it beside an important path and within view of many buildings. The Heart of Campus kiosk is an example of a Public Outdoor Room.



Quadrangles and the Historic Core

College campuses are unusual in that their buildings form coherent larger outdoor spaces. Each building is complete in itself, yet the walls form large public open spaces punctuated by the building entrances that open onto them and by cross axes that flow through them, connecting them to other open spaces. These rectilinear, axial open spaces such as malls and quadrangles are the basic framework of the University of Oregon’s historic campus core, which is a part of the campus’s larger open-space framework. Without a specific effort to preserve them, these components of the open-space framework may be diminished or lost because building projects fail to consider them beyond the bounds of the project.

THEREFORE: When building in the historic campus core, create buildings or additions that support and enhance the existing open-space framework of quadrangles and axes.



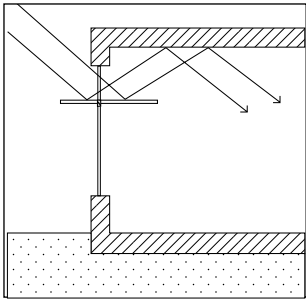

Quality of Light

Daylight, the use of which results in energy savings, is an important aspect to wellness and psychological comfort for building users; it is also beneficial to many of the tasks performed by building occupants. However, glare from daylighting may cause eye strain for employees who use computer monitors.

THEREFORE: Provide ample opportunities for daylight throughout the building in both private and public areas. When possible and appropriate, opportunities to bring natural light into areas further from the perimeter of the building such as clerestory windows, interior windows, or windowed doors should be considered. Provide appropriate shading and defusing devices and furniture arrangement to eliminate glare on computer screens.

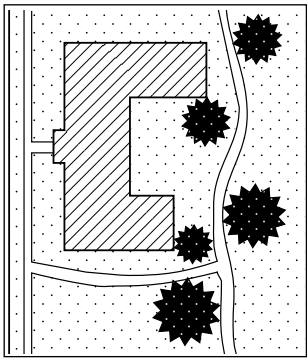

Quiet Backs

Anyone who has to work in noise or in offices with people all around needs to be able to pause and refresh with quiet in a more natural situation.

THEREFORE: Give buildings in the busy parts of campus a quiet “back” behind them and away from the noise. Along this quiet back build a walk that is far enough from the building so that it gets full sunlight but is protected from noise by walls and distance and buildings. Make certain that the path is not a natural shortcut for busy foot traffic, and connect it to other walks to form a long ribbon of quiet alleyways that converge on open spaces.

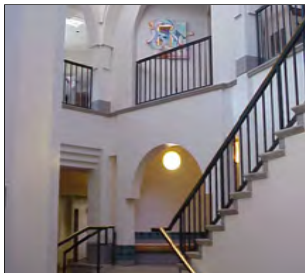

Research Ties

Research areas often need to be connected to each other so that shared equipment can be moved around. Scientists and other researchers need to be near their colleagues so they can share information and ideas.

THEREFORE: Link research domains with covered, level, possibly enclosed, and heated spaces. Use these links between the domains as opportunities for social interaction and support facilities.

Road Crossings

Where paths cross roads, cars have the power to frighten and subdue pedestrians, even when the pedestrians have the legal right-of-way.



THEREFORE: At a point where a pedestrian path crosses a road within the campus (see “Local Transport Area” pattern) make a “knuckle” at the crossing: narrow the road to the width of the through lanes only; use different paving materials to continue the pedestrian path through the crossing and raise it above the roadway; and/or install islands between lanes. Be careful to consider the safety of blind people. Make pedestrian movement more of a priority than car movement.

Seat Spots

Where outdoor seats are set down without regard for view and climate, they will almost certainly be useless.

THEREFORE: Choosing good spots for outdoor seats is far more important than building fancy benches. Indeed, if the spot is right, the most simple kind of seat is perfect. Choose locations facing the sun or in the sun, and look for opportunities where seats can face activities.



Shielded Parking and Service Areas

Parking lots full of cars are inhuman and dead spaces—no one wants to see them or walk by them. Loading docks and service areas also are cluttered and unkempt spaces containing unattractive garbage-filled dumpsters.

THEREFORE: Put all parking lots and service areas behind some kind of screening wall, so that the cars and dumpsters cannot be seen in passing; at the same time take into account the security of the users of these facilities. The surrounding wall may be a building, a low landscape wall, earth berm, or hedge.



Site Repair

Buildings must always be built on those parts of the land that are in the worst condition not the best.

THEREFORE: Never place buildings in the most beautiful places. In fact, do the opposite. Consider the site and its buildings as a single unit. Leave as they are those areas that are the most precious, beautiful, comfortable, and healthy, and build new structures in the least pleasant parts of the site.

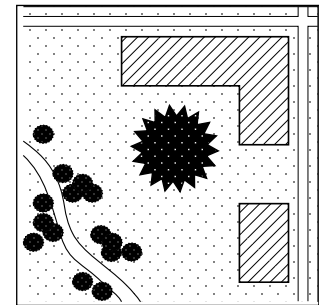

Sitting Wall

In many places low walls are needed to accommodate different landscape levels. Often these are along walkways or at the edges of open areas, which also make great places to sit and rest, think, or watch the world go by.

THEREFORE: Make landscape walls about 17-19 inches high and 12-14 inches wide to accommodate sitting. Do this especially alongside areas of activities to give people a place to sit and watch or to carry on a conversation begun with a chance meeting. Look for sunny places. Design these walls to discourage skateboarding along their tops.

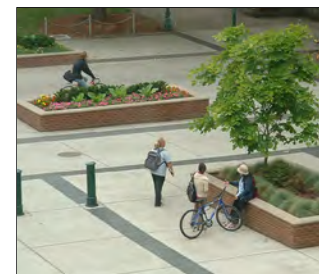

Small Parking Lots in Campus Core

Vast parking lots wreck the land for people.

THEREFORE: In the core of the campus (see “Local Transport Area” pattern), make parking lots small, for 20-30 cars. If a lot requires more parking, build it up as a collection of these 20-30-car lots, along a spine, each lot bounded and enclosed with a low wall, low hedge, or earth berm. (See “Shielded Parking and Service Areas” pattern.)



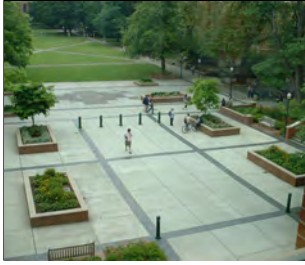

Small Public Squares

A campus needs public squares; they are the largest, most public rooms on the campus. But when they are too large, they look and feel deserted.

THEREFORE: Make a public square much smaller than first imagined, usually no more than 45 to 60 feet across, never more than 70 feet across. This applies only to its width in the short direction. Its length can certainly be longer.

South Facing Outdoors

People use open space if it is sunny, and they don't use it if it isn't.

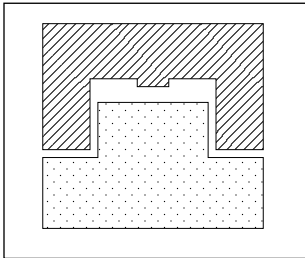

THEREFORE: Place buildings so that the open space intended for use is on the south side of the buildings. Avoid putting open space in the shadow of buildings. And never let a deep strip of shade separate a sunny area from the building it serves.

Spillover Parking

Parking systems adopted for the campus should avoid creating parking problems for surrounding residential neighborhoods.

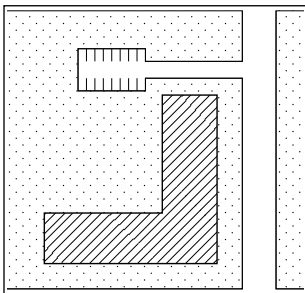

THEREFORE: Provide appropriately placed, adequate off-street parking in conjunction with any new institutional use that creates demand for parking that cannot be met by current parking supplies. Take steps to gain better use of existing off-street parking areas, and work with the City of Eugene to discourage long-term storage of vehicles on the residential streets surrounding the campus. (See “Principle 9: Transportation” on page 81.)

Student Housing

When students live too far from campus, it is more difficult for them to be part of university life. Aside from the educational benefits to students of living on campus, on-campus housing contributes to the vitality and quality of campus life and a sense of community. Undergraduate students especially gain the primary academic benefit of on-campus housing.



THEREFORE: Recognize the value of proximity when locating student housing, in particular housing for entering undergraduate students. Design and locate undergraduate on-campus residence hall housing for entering students so that it supports the goal of integrating the academic life with the residential experience. Also ensure access to food service for residence hall students. Establish a balance between dense housing, which is generally more affordable, and livability.

Sustainable Development* [See “Principle 10: Sustainable Development” on page 85 for requirements.]

Today’s development, repair, maintenance, and operations of the University of Oregon have an impact on the local environment and the ability of future generations to thrive. The physical environment of the university—its landscape and buildings—must also support and enhance the excellence of our academic programs.

THEREFORE: Develop, redevelop, and remodel in ways that incorporate sustainable design principles.

Tree Places

When trees are planted or pruned without regard for the special places they create, they are as good as dead for the people who need them.

THEREFORE: Plant trees according to their nature, to form enclosures, avenues, squares, groves; plant single-spreading trees toward the middle of open spaces. Shape the nearby buildings in response to trees, so that the trees themselves and the trees and buildings together form places people can use. (See the *Campus Tree Plan*.)

Universal Access* [See “Principle 8: Universal Access” on page 77 for requirements.]

In addition to complying with applicable federal and state requirements, the university is committed to making all new facilities welcoming and accessible for all users without discriminating on the basis of ability. This inclusive environment enables all users to participate equally in the university’s programs, activities, and services.

THEREFORE: Design improvements to the campus in ways which ensure welcoming, graceful access for all members of its community.

University Shape and Diameter* [See “Principle 4: Space Use and Organization” on page 55 for requirements.]

When a university is too spread out, people cannot make use of all it offers. On the other hand, a campus diameter based strictly on the ten-minute class break is needlessly restrictive.

THEREFORE: Plan all classes, evenly distributed, within a circle that can be crossed within a seven-minute walk. Place non-class activities such as housing, research offices, and administration outside this circle.

Use Wisely What We Have

New construction reduces limited land inventories and valuable natural resources on and off campus. Development projects also may put pressure on green open spaces, landscape features, and historic resources that contribute to the university’s cultural character and stimulating intellectual environment.

THEREFORE: All new campus growth should promote efficient development and, whenever beneficial, make use of existing facilities to preserve valuable open space and historic resources.

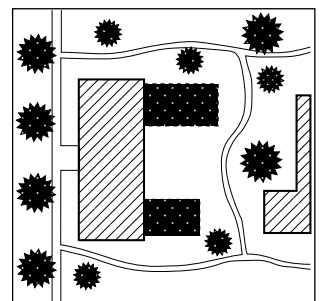
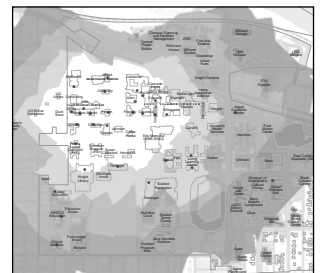
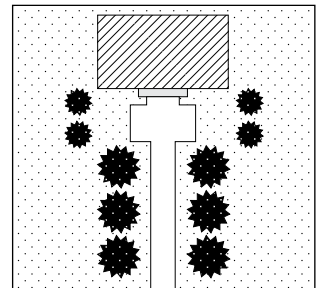
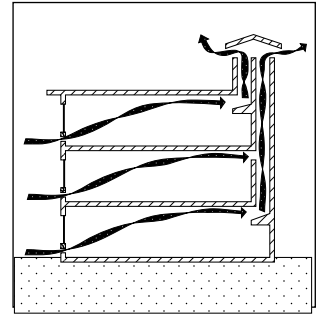



Water Quality

Water quality is directly affected by the manner in which developed lands treat rainwater. The water quality in rivers is enhanced if rainwater is cleaned (by removing car oils and other impurities) or dispersed slowly on a developed site before it enters the city's engineered storm-water systems.

THEREFORE: Provide opportunities for rainwater to be cleaned and dispersed on the development site. Consider green roofs or bioswales when designing, but be mindful of the groomed nature of the campus and its accompanying maintenance requirements.



Welcoming to All

Built environments in which the greatest range of diverse people feel welcome and comfortable promote learning opportunities and encourage an open exchange of ideas.

THEREFORE: Create a campus that addresses the issues of diversity and equity in the built environment, for example, in landscapes, building layout, design details, and artwork.

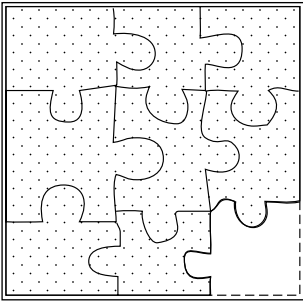

Wholeness of Project

Funding limitations often lead user groups or designers to create phased projects (in the hope of obtaining more funding for later phases) or to use the funds to create more new space without solving the existing facility's problems. These approaches can result in a complicated facility with functional problems, an awkward feel, and a lack of wholeness and integrity.

THEREFORE: Approach the project as a single-phased whole, creating a usable facility with options for future development. Address existing building problems directly, for example through renovations, rather than assuming they will be solved simply by adding new space. This approach may result in compromises, but it gives project users confidence that the built project will suit their needs.

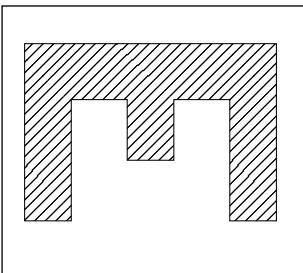

Wings of Light

Buildings are often shaped without concern for natural light and depend almost entirely on artificial light. Buildings that do not allow natural light as a source of illumination are not comfortable places to spend the entire day.

THEREFORE: Shape buildings in ways that allow natural light to penetrate far into their centers. Use ideas like light shelves to bounce daylight even further into the building's spaces. Usually this will mean buildings that have wings less than about 50 feet in width.

PRINCIPLE 12



DESIGN AREA SPECIAL CONDITIONS

PRINCIPLE 12: DESIGN AREA SPECIAL CONDITIONS



Principle

The campus is composed of approximately 295 acres. Within this vast area smaller areas of campus exist, each with its own distinct feel and history. High-quality development requires attention to the unique details that give each of these Design Areas its own character.

To ensure that the unique characteristics of specific areas are not overlooked, all proposed construction projects shall consider the special conditions below.

Pattern Summary

This chapter addresses the development of all areas of the campus; therefore, all patterns listed in “Principle 11: Patterns” (page 91) apply.

Design Area Special Conditions

Design Area Special Conditions shall be considered whenever construction is proposed for a particular Design Area (Design Areas are further described in Principle 3: Densities, page 49).

Design Area Special Conditions provide specific guidance for development and building use in the part of campus to which they apply. These conditions are organized by Designated Open Spaces because the university’s open-space framework is the primary design element that defines the campus character.

DESIGN AREA	
SPECIAL CONDITIONS TABLE OF CONTENTS	
Academic Center & Historic Core	p.112
Franklin Triangle	p.123
PLC Parking Lot	p.125
Southwest Campus	p.126
Millrace	p.129
Willamette	p.137
Northeast Campus	p.141
Northeast Central Campus	p.147
Southeast Campus	p.155
Student Housing	p.159
Athletics, Student Support, & Administration	p.164
East Campus	p.167

(A larger map is available on page 50)

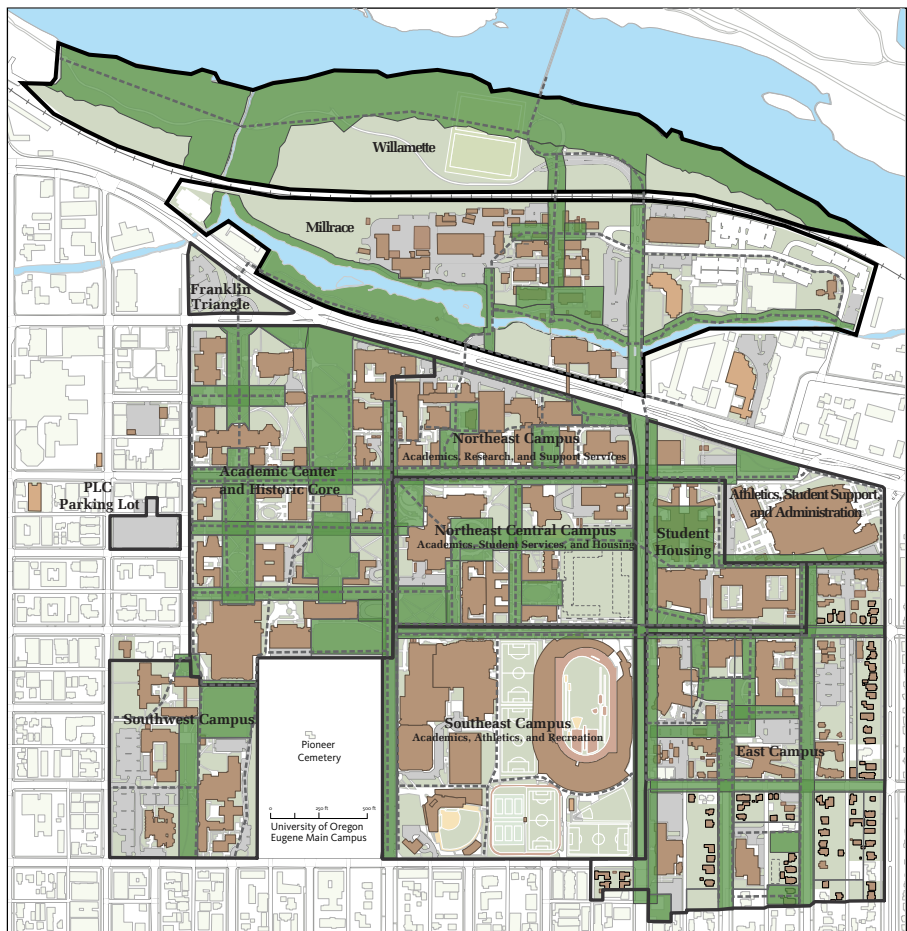
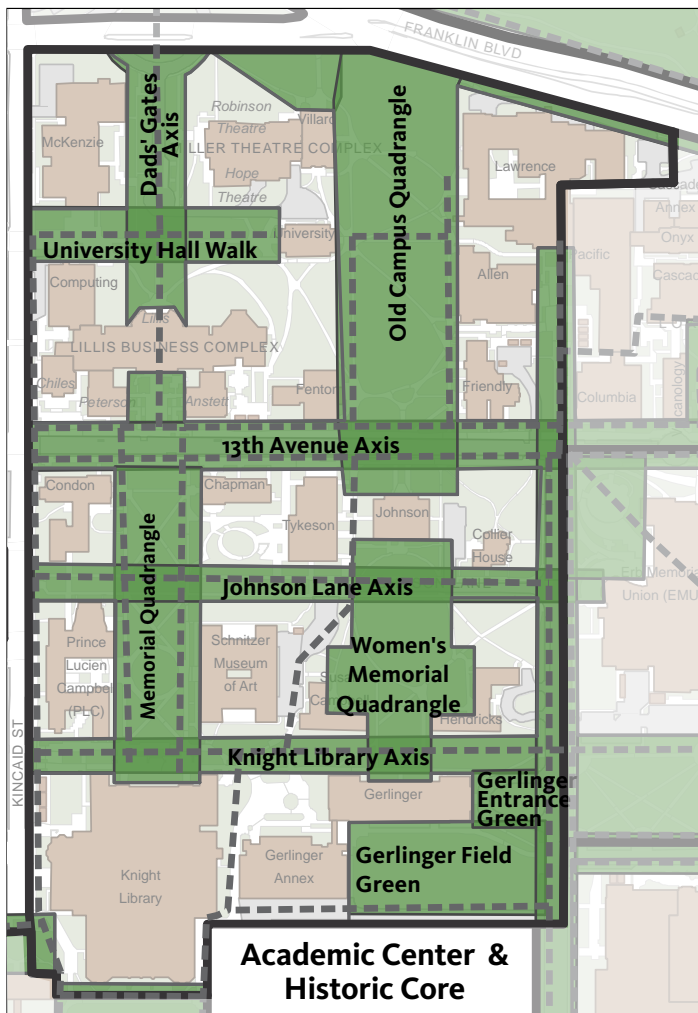

Diagram of Campus Design Areas

Design Area

ACADEMIC CENTER AND HISTORIC CORE



The size of the Design Area is 1,827,250 square feet. Approximately 48% is Designated Open Space.



University Hall Walk, 1900.



University Hall Walk, 2018.

This design area includes the original university campus, and it continues to be the major academic core. Although it is not particularly densely developed, the requirements for passive open space and preservation of historic resources preclude additional development in significant amounts.

Area-wide Space Use Comments

To the extent possible, surface parking within this region shall be minimized and developed as parking courts or plazas/landscape areas with emphasis on pedestrian movement. An example of this is located to the east of Jordan Schnitzer Museum of Art. Another candidate for this treatment is the area between University and Villard Halls.

In consideration of the existing and traditional use of buildings in this area for central administrative purposes, the general principle (see “Principle 4: Space Use and Organization,” page 55) favoring use of central campus buildings for instructional or instructional-related purposes is modified. It would be appropriate to locate in this area an administrative office that requires frequent face-to-face contact with the faculty or with the president in order to satisfactorily perform the duties assigned to it.

Campus Edges: 11th Avenue/Franklin Boulevard and Alder Street/Kincaid Street

The university owns land on both sides of this busy boulevard, and development along the Franklin Boulevard edge is highly visible to the public. It is the primary automobile entrance to the university and often provides the first (and sometimes only) impression of the university for visitors and community members. Every opportunity should be taken to improve the visual qualities of this area and convey the university's public role, mission, and history.

University ownership on both sides of the boulevard gives an opportunity to convey the image of driving “through” rather than “by” the campus.

Clear visual clues (preferably through design features rather than signage) identifying the university and entry or parking routes are essential. Every effort should be made to locate auto parking near this high-traffic edge to avoid auto traffic in the campus core and adjacent neighborhoods.

Extra care should be taken to preserve and enhance views into and of the campus, in particular views of historically significant features including Dads’ Gates, the Villard Hall Green (and Villard Hall), and the Old Campus Quadrangle (the Condon oak in particular).

The edge along 11th Avenue has become more active with the completion of the bus rapid transit EmX route and stop at Dads’ Gates making pedestrian amenities that enhance access and safety more important. The large, blank retaining wall at the intersection of 11th Avenue and Franklin Boulevard is a poor example of an inviting campus edge, both for the pedestrian and auto driver.

The Alder Street/Kincaid Street edge is adjacent to a highly active university-related commercial area and Northwest Christian University. The highest levels of pedestrians, bicyclists, and bus riders enter the university from here, particularly at 13th Avenue. Prior gateway improvements at the 13th Avenue and Knight Library Axes have been very successful. Similar gateway and sidewalk improvements at other pedestrian points of entry are encouraged in order to create a more welcoming university entrance, convey a positive image, and deter cut-through foot traffic in landscaped areas. Providing safe routes of travel for all modes of transportation at this very active edge is a challenge. Pedestrians, bicyclists, and transit buses have priority.

Construction along Alder Street and Kincaid Street should consider the principles in the City of Eugene’s *West University Refinement Plan*.

VILLARD HALL GREEN

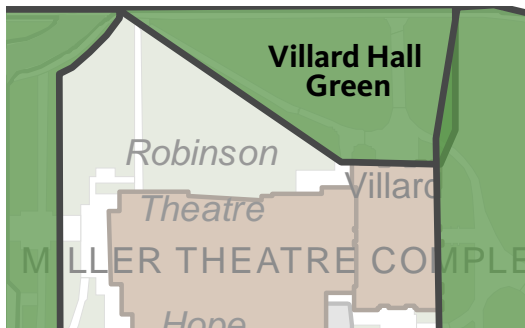

Current Use

This area is used by pedestrians. Lying within the Villard Hall National Landmark boundary, it is prominently situated adjacent to 11th Avenue and Franklin Boulevard and provides views of Villard Hall.

Pathways/Gateways

Pedestrian use of this area increased due to the completion of the bus rapid transit EmX station at Dads’ Gates.

Form

This area has a traditional, informal arrangement of mature conifers interspersed in a lawn setting.

Trees/Landscape

Significant trees include mature Douglas firs and two mature Ponderosa pines that flank the walkway leading from Dads' Gates to Villard Hall. The Dawn redwood north of Robinson Theatre is a significant nearby tree. (Refer to the *Campus Heritage Landscape Plan and Survey of Historic Buildings and Landscapes*.)

Opportunities and Constraints

The existing character of this area should be preserved and enhanced. There is no potential for development in this area. (Refer to the Academic Center and Historic Core Diagnosis.)

DADS' GATES AXIS

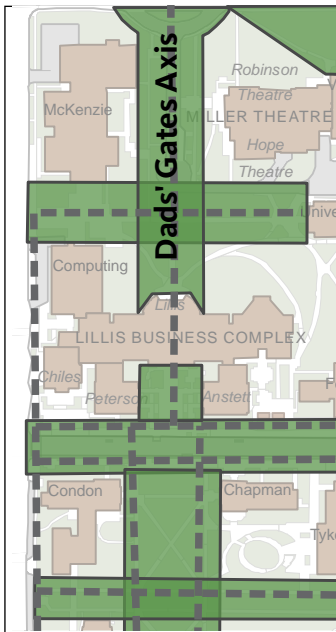

Current Use

The primary use of the axis is by pedestrians, with some service vehicles and autos using the few short-term parking spaces within the area. This axis was originally conceived by Ellis Lawrence as the formal entrance to the campus. The southern end facing the Memorial Quadrangle is heavily used as an informal gathering place.

Form

The axis begins at Dads' Gates (11th Avenue), continues to 13th Avenue, and is bisected by the Lillis Hall atrium space. The portion north of Lillis Hall is defined by two big-leaf lindens and two European beeches flanking Dads' Gates as well as the landscaping associated with Miller Theatre Complex. It consists partly of a service drive and partly of grassy, open space interspersed with informal plantings of conifers. The portion of the axis south of Lillis Hall (Gilbert Plaza) is defined primarily by Anstett and Peterson Halls (both Ellis Lawrence buildings) and a mature yellow buckeye.

Pathways/Gateways

This axis serves as a pedestrian gateway to campus. Pedestrian use substantially increased with completion of McKenzie Hall, Lillis

Business Complex, and the bus rapid transit EmX station at Dads' Gates. The axis has become an important link between 11th Avenue and 13th Avenue.

Trees/Landscape

The Giant Cryptomeria class tree (class of 1879) and the Sequoia class tree (class of 1880) in the area north of the University Hall Walk are of special significance. The black walnut class tree (class of 1894) near Dads' Gates is also of special significance. The class tree of 1898, a California laurel located in front of Robinson Theatre, died in the early 2000s and was replaced. The Ohio buckeye located in Gilbert Plaza is of special significance.

Two trees adjacent to the designated open space are of special significance. They are the smoothleaf elm class tree (class of 1883) north of the University Hall Walk Axis, and the Dawn redwood north of the Miller Theatre Complex, which was one of the two Dawn redwoods planted on the campus from the original shipment of seed from China. The 1885 Normal Gate adjacent to the Miller Theatre Complex is of special significance. (Refer to the *Campus Heritage Landscape Plan and Survey of Historic Buildings and Landscapes*.)

Opportunities and Constraints

The portion of the axis south of Lillis Hall (Gilbert Plaza) should remain open as an intentionally sunny, south-facing spot. Public pedestrian access through the Lillis atrium space should be preserved to maintain the important north/south axial pathway.

Proposals for development and tree plantings in this area should preserve and strengthen the axis, in particular its northern portion. Proposals should acknowledge that Dads' Gates create a visible public gateway that is listed in the National Register of Historic Places. Pedestrian and bike improvements are encouraged, and parking should not be featured.

A replacement program to anticipate the decline of the numerous mature trees and maintain the desired canopy character along this axis is necessary. The remaining class trees and Normal Gate deserves special care. Refer to the Academic Center and Historic Core Diagnosis.)

UNIVERSITY HALL WALK AXIS

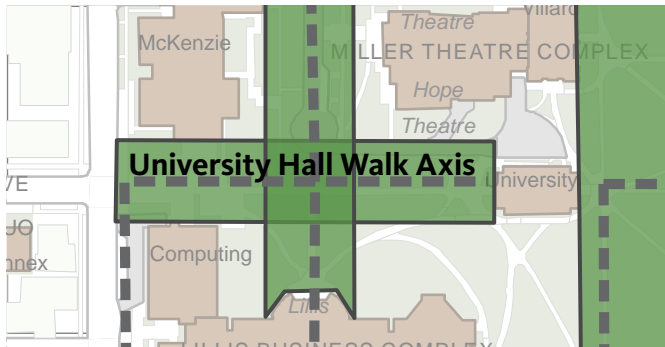

Current Use

This walkway, which aligns with 12th Avenue, is used exclusively by pedestrians. In the early years of the university, it was the path by which townspeople came to the university from Eugene, which lay entirely to the west of the present-day campus. It is an important view corridor to University Hall, the most historically significant building on campus.

Form

Its form derives from the row of Douglas firs and the rise in elevation to the west door of University Hall. The plaza at Kincaid Street is defined by main building entrances to the north and south.

Pathways/Gateways

Its intersection with Kincaid Street is one of a series of pedestrian entries to the university from the west and makes an important connection to the Old Campus Quadrangle.

Trees/Landscape

This axis leads from University Hall to Kincaid Street and is clearly delineated by two formal rows of Douglas firs bisected by the Dads' Gates axis. Nearby significant trees include the Giant Sequoia, Giant Cryptomeria, and Dawn Redwood (north of Villard Hall). (Refer to the *Campus Heritage Landscape Plan and Survey of Historic Buildings and Landscapes*.)

Opportunities and Constraints

Proposals for development in this area (for example, McKenzie Hall plaza improvements or a vertical addition to the Computing Center) need to preserve and strengthen this view corridor. A good opportunity for an entrance gate exists where the walk intersects with Kincaid Street. Proposals also should acknowledge that University Hall is a National Landmark.

The Douglas firs are to be afforded extra care and should be replanted as they die.

(Refer to the Academic Center and Historic Core Diagnosis.)

OLD CAMPUS QUADRANGLE

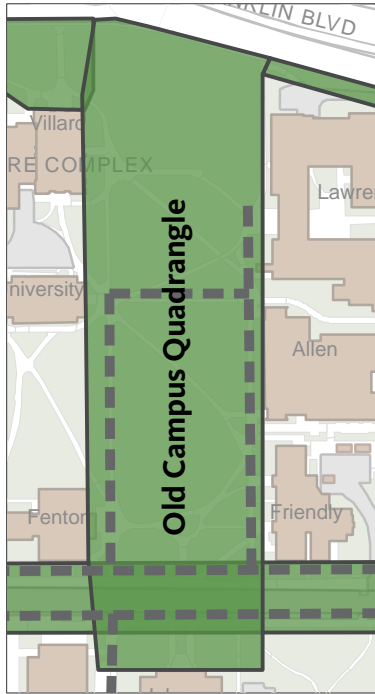

Current Use

This area is heavily used by pedestrians and serves as a quiet refuge from the surrounding activities.

Form

Historically this quadrangle represents the first open space on campus and has evolved into a quiet, park-like setting. It is defined by the university's oldest and most historically significant buildings, University and Villard Halls, among others. At its southern end is Johnson Hall; its northern end terminates at a wall several feet above Franklin Boulevard. Main building entrances generally face the quadrangle.

Pathways/Gateways

This space is crisscrossed with pedestrian pathways. The southern end of this quadrangle is crossed by the 13th Avenue Axis, an important east/west connection on the campus. The pathways along the east and west edges of the quadrangle connect the 13th Avenue Axis to buildings and to minor pathways leading to destinations on the east and west edges of the quadrangle. The northern end of the quadrangle is a visual gateway to the Millrace, the river and their associated mature landscapes.

Trees/Landscape

The quadrangle has an informal landscape arrangement primarily of conifers with under-story shrub plantings interspersed in a lawn setting. There is also a large collection of magnolias primarily along the edges of the quadrangle.

The open space in which the remaining Condon oak is situated is to be preserved.¹³ A number of other trees in this quadrangle are significant: the European linden located east of Villard Hall (1895 class tree), the big-leaf maple near the southeast corner of University Hall (the sole survivor of the original campus planting of 1884), the sequoia (class of 1892), and the Threadleaf Japanese maple near 13th Avenue northeast of Johnson Hall (because of its size and unique character). (Refer to the *Campus Heritage Landscape Plan and Survey of Historic Buildings and Landscapes*.)

Opportunities and Constraints

In contrast to the Memorial Quadrangle, well-located seating within this quadrangle is encouraged. Proposals for development in this area must account for preserving and strengthening the Old Campus Quad. For all practical purposes the area is developed to capacity, and additional academic program space will need to be developed from modest vertical expansion (for example, on Lawrence Hall) or from reassignment of existing space. (Refer to the design guidelines in the *Campus Heritage Landscape Plan*.)

Proposals shall account for buildings and landscape features with historic significance including those listed as National Landmarks (Villard and University Halls) or in the National Register of Historic Places (Johnson Hall).

The view corridor from *The Pioneer Mother* (removed June 2020) through the Johnson Hall lobby to the *Pioneer* (removed June 2020) and the view north to the Millrace and the river should be preserved. Some outdoor furniture and similar accessories intended to aid in the enjoyment of this special area would be appropriate. (Refer to the Academic Center and Historic Core Diagnosis.)

¹³ When University Hall was built in 1876 it was situated on a barren knoll in a treeless pasture, with the possible exception of the two Condon oaks that were prominently situated just north of the designated open space adjacent to Franklin Boulevard. These trees were later adopted by the classes of 1897 and 1900. In 2004, one of the Condon oaks (class of 1900) was replaced due to its poor condition related primarily to old age.

13TH AVENUE AXIS: KINCAID STREET TO UNIVERSITY STREET

(See descriptions in the Academic, Research, and Support Services Design Area for the University Street to Agate Street portion of this axis, page 142 and Student Housing Design Area for the Agate Street to Moss Street portion, page 161)

Current Use

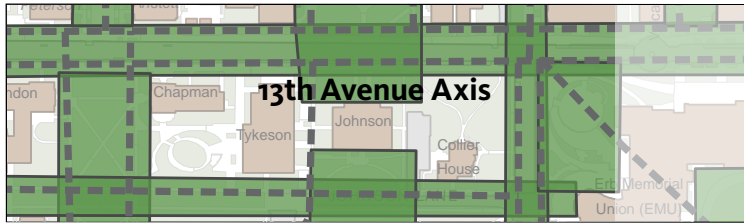

This primary axis has heavy pedestrian and bicycle use (only restricted service traffic is allowed) and connects the Heart of Campus to Kincaid Street and to the Memorial and Old Campus Quadrangles. Special events such as the street fair take place in this area.

Form

This axis has a traditional street design modified by projects such as Lillis Business Complex and Heart of Campus. Landscape elements within the paved street area have enhanced the street's pedestrian quality through the removal of curbs, new tree planting areas, and special paving. Buildings help define the axis and its relationship to intersecting open spaces. Although most buildings are entered from the adjoining quadrangles, the main entrances are clearly visible from the axis.

Pathways/Gateways

The western end of this axis is a major entry to the campus from the nearby west university business district and two major LTD bus transit stations. In some ways this is the premier campus pathway as it connects practically every aspect of the campus internally, to the business district on the west, and to the residential areas to the east. As a public institution, the university needs to be welcoming and open to the public. The west end of this axis is one of several campus places for a public gateway and entrance. This gateway is a symbolic marker of the connection between the community and the university.

Trees/Landscape

The axis is lined on either side with a double row of primarily large-canopy trees including big-leaf maples, London plane trees, and catalpas. Nearby significant trees include the Threadleaf Japanese maple in front of Johnson Hall, and the Port Orford cedar and Sitka spruce on Collier House grounds. (Refer to the *Campus Heritage Landscape Plan and Survey of Historic Buildings and Landscapes*.)

Opportunities and Constraints

Special attention should be given to the safety of pedestrians and bicyclists, who share this axis with service, delivery, and emergency vehicles. The design of this axis emphasizes pedestrians and bicycles; however, a system of paving is needed to delineate more clearly the paths each type of user should take in order to ensure safe movement within the axis. Landscape features such as bicycle racks, trash cans, lights, and signage can be employed to serve as indicators of these paths.

Development of the edges of the axis should accommodate the large volumes of pedestrian traffic while also providing seating opportunities (like low walls) and discrete areas for seating. Good examples include the area south of Fenton Hall, the area east of Friendly Hall, and the area north of Condon Hall near the 13th Avenue/Kincaid Street gateway.

Development of the axis where it crosses the Memorial Quadrangle and the Old Campus Quadrangle must recognize these quadrangles by leaving the axis free of bicycle parking and other elements that might interrupt the space. A good example of this is the Memorial Quadrangle where it crosses the axis at Lillis Hall. In addition, the view corridor from *The Pioneer Mother* (removed June 2020) through the Johnson Hall lobby to the *Pioneer* (removed June 2020) should be preserved.

Efforts to shade the street surface, particularly to replace the missing large-canopy trees, are a priority. However, care should be taken not to interfere with adjacent sunny open spaces, such as the Memorial Quadrangle and Gilbert Plaza. Placement of trees should not block the ground-level view from Lillis Hall to Knight Library.

The historic character of Collier House (City Landmark) and Johnson Hall (National Register) site should be considered when selecting and placing trees; in particular, new plantings should recognize the unique nature of the plantings around Collier House.

Maintaining and enhancing the gateway at the intersection of 13th and Kincaid is important to acknowledging the symbolic and literal relationship between the public and the institution that serves it. (Refer to the Academic Center and Historic Core Diagnosis.)

MEMORIAL QUADRANGLE

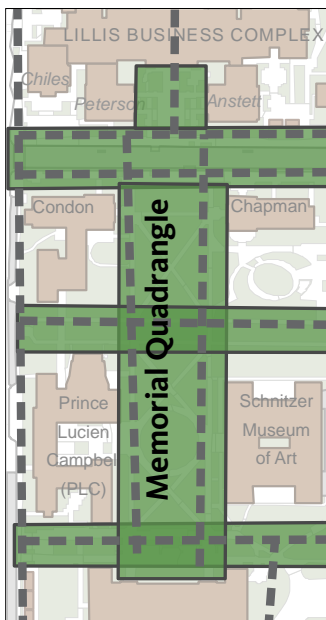

Current Use

This quadrangle is used exclusively by pedestrians and is the university's largest formal outdoor space. The northern end is intentionally sunny and is heavily used as both a formal and an informal gathering place.

Form

This quadrangle is defined by an ensemble of Lawrence buildings. The quadrangle represents the university's most formal "outdoor room" and, as befitting a traditional quadrangle, all of the surrounding buildings have their front doors facing this open space.

Pathways/Gateways

Three east/west pathways (13th Avenue, Johnson Lane, and Knight Library Axes) cross this quadrangle at its ends and across its center. North/south pathways form the east and west edges of the quadrangle. An important pathway to the Southwest Campus connects to this space along Kincaid Street.

Trees/Landscape

The eight pyramidal English oaks at the southern end are significant trees, which help form the identity of the quadrangle. (Refer to the *Campus Heritage Landscape Plan and Survey of Historic Buildings and Landscapes*.)

Opportunities and Constraints

Few additional possibilities exist for new buildings along the edges of the quadrangle, but there are options for additions to existing buildings. Any new construction, repair, or replacement abutting the Memorial Quadrangle (for example, an addition to Chapman, Condon, or PLC Halls) shall acknowledge the special significance to the university of this ensemble of buildings and open spaces. The quadrangle itself, along with Knight Library and Jordan Schnitzer Museum of Art, is listed in the National Register of Historic Places. Additions should not overpower or detract from the existing buildings and should be set back from the quadrangle edge. One exception to this could be an addition to Prince Lucien Campbell Hall, which might both establish a formal entrance to the building from the quadrangle and create a balance to Jordan Schnitzer Museum of Art.

Seating, such as benches, is prohibited within the quadrangle's confines but is encouraged along its edges. Extra care is to be given to the quadrangle's repair and renovation and to the introduction of any new plantings. The treeless sunny northern end of the space is a significant gathering place for students in good weather and should remain treeless. The view between Knight Library and Lillis Business Complex shall remain open. (Refer to the Academic Center and Historic Core Diagnosis.)

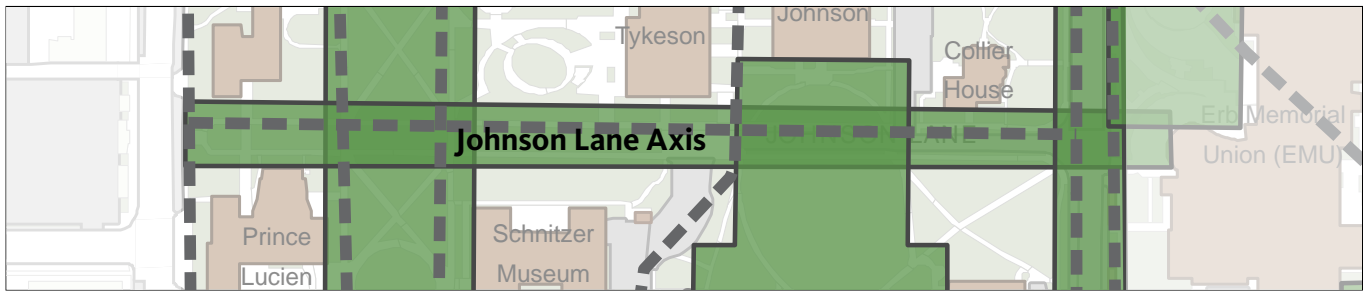

JOHNSON LANE AXIS

Current Use

Pedestrians moving between University Street, the Memorial Quadrangle, and Kincaid Street are the primary users of this axis. Johnson Lane is a designated bicycle route, used also by cars parking in two small, nearby parking lots, and by service vehicles (including large trucks) accessing Jordan Schnitzer Museum of Art and Chapman, Johnson, and Susan Campbell Halls.

Form

This axis is partially defined by Johnson Lane, a bike route and limited auto access route, and extends as a pedestrian access from the EMU across the Memorial Quadrangle to Kincaid Street. The north and south edges of the axis are not well defined by buildings.

Pathways/Gateways

This axis serves as a major connector in the east/west direction between University Street and Kincaid Street. The western terminus of the axis is the entry point to the Memorial Quadrangle from Kincaid Street and the large PLC parking lot to the west and as such serves as a gateway to the campus.

Trees/Landscape

The Johnson Lane portion is defined loosely by a mix of primarily deciduous trees planted on either side of the lane. The pedestrian portion between Chapman Hall and Jordan Schnitzer Museum of Art consists of an open, grassy lane with an informal mix of conifers on the south side and a row of tulip trees on the north side. The axis is further defined at its intersection with the Memorial Quadrangle by three English oaks and a tulip tree. The western end of the axis has a mix of deciduous trees and terminates at the LTD bus transit station and the PLC Parking Lot (page 125). Nearby significant trees include the Port Orford cedar on the Collier House grounds and the Sitka spruces at the southwest corner of the Johnson Lane and University Street intersection. (Refer to the *Campus Heritage Landscape Plan and Survey of Historic Buildings and Landscapes*.)

Opportunities and Constraints

Projects in this area should preserve and strengthen the axis and complete development of the Women's Memorial Quadrangle, which is framed on the south by Hendricks and Susan Campbell Halls (all are listed in the National Register of Historic Places). Development of buildings on either side of the axis must accommodate bicycles and service vehicles. A new campus gate at the western terminus of this axis (at Kincaid) would allow for the resolution of pedestrian traffic along Kincaid, redirecting it to safer crossing points and could also provide an opportunity for Jordan Schnitzer Museum of Art to highlight its current offerings. Further research is needed to determine how to better define this axis with more formal tree plantings, especially along Johnson Lane. (Refer to the design guidelines in the *Campus Heritage Landscape Plan*).

(Refer to the Academic Center and Historic Core Diagnosis.)

WOMEN'S MEMORIAL QUADRANGLE

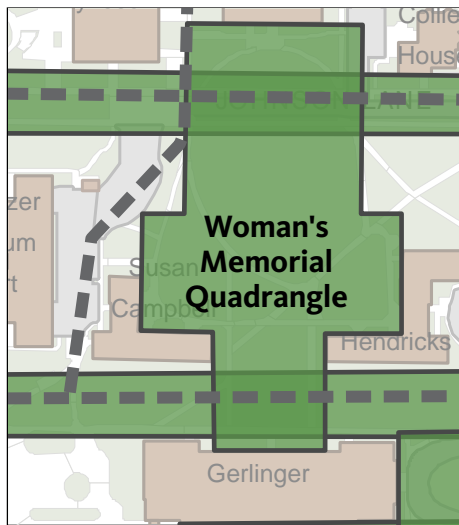

Current Use

This quadrangle is a quiet pedestrian area that provides a view corridor from *The Pioneer Mother* (removed June 2020) through the Johnson Hall lobby to the *Pioneer* (removed June 2020). The space is often used for formal gatherings.

Form

This grassy area has a traditional campus character with informal plantings of mature large-canopy shade trees. It is defined by the ensemble of Ellis Lawrence buildings and Johnson Hall.

Pathways/Gateways

The northern portion is crossed by the Johnson Lane Axis, an important east/west connector for the campus. The southern edge is crossed by the Knight Library Axis, which is also an important east/west connection.

Trees/Landscape

The axis contains several mature trees placed in an informal arrangement. As noted above, careful planning will need to precede further development of buildings surrounding this axis in order to preserve the forested nature of the area. The Scarlet oaks are of particular significance. (Refer to the *Campus Heritage Landscape Plan and Survey of Historic Buildings and Landscapes*.)

Opportunities and Constraints

Projects in this area should preserve and strengthen the quadrangle while completing the composition of buildings (Hendricks, Susan Campbell, Gerlinger, and Johnson Halls) begun by Ellis Lawrence and all listed in the National Register of Historic Places. The composition of buildings needs to enhance the quadrangle by having the buildings' long dimensions parallel to Johnson Lane. The main entrances to these buildings should be from University Street or Johnson Lane. The view corridor from the *Pioneer* (removed June 2020) to *The Pioneer Mother* (removed 2020) (through the Johnson Hall lobby) is to be preserved. Some of the existing trees associated with this open space are not located within the Designated Open Space and may be subject to removal when future development takes place. An effort to plan for this outcome by planting trees within the designated Women's Memorial Quadrangle and the adjacent Johnson Lane Axis, which are less likely to be affected by future development and the re-establishment of the oval walkway, would minimize this potential loss. (Refer to the design guidelines in the *Campus Heritage Landscape Plan*.)

(Refer to the Academic Center and Historic Core Diagnosis.)

KNIGHT LIBRARY AXIS



Current Use

The primary purpose of this axis is to connect pedestrians from Kincaid Street on the west end to the Memorial Quadrangle, the Women's Memorial Quadrangle, the University Street Axis, and finally the Straub Hall Green on the east end.

Form

This is the third of three axes that cross and connect the major open spaces created by Ellis Lawrence. Its north edge is formed by PLC, Susan Campbell, and Hendricks Halls; its south edge is formed by Knight Library's terrace and fountain and by Gerlinger Hall.

Pathways/Gateways

Its western end is framed by the library gateway. It connects to two important pathways leading to the Southwest Campus area. This axis connects to a path along the edge of the Straub Hall Green that is centered on the entrance to Straub Hall and could become a significant pathway to the residence hall area (through Straub and Earl Halls). (See Northeast Central Campus--Academics, Student Services, and Housing Design Area on page 147.)

Trees/Landscapes

The axis has a traditional campus character with informal plantings of mature, large-canopy shade trees planted on either side of the walkway. The large European beech tree south of Jordan Schnitzer Museum of Art is an excellent example of its type, and it contributes significantly to the character of the axis. The Black walnut tree is significant as well. (Refer to the *Campus Heritage Landscape Plan and Survey of Historic Buildings and Landscapes*.)

Opportunities and Constraints

The sidewalk arrangement east of the Memorial Quadrangle is informal with one sidewalk transversing the axis's southern edge. Opportunities may exist to create a more formal arrangement of sidewalks. No opportunities exist for new buildings along its edges, and replacement buildings should have their main entrances off the surrounding quadrangle or axis. (Refer to the Academic Center and Historic Core Diagnosis.)

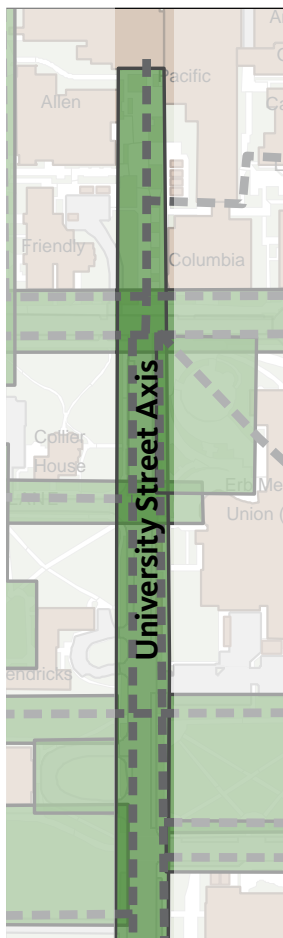

UNIVERSITY STREET AXIS: LAWRENCE HALL TO 15TH AVENUE

(See description in the Southeast Campus--Academics, Athletics, and Recreation--Design Area for the 15th Avenue to 18th Avenue portion of this axis, page 157.)

Current Use

The portion of the axis north from 13th Avenue (known as the Lawrence Hall view corridor) provides exclusive pedestrian access to Lawrence, Allen, and Pacific Halls. The portion of the axis from 13th to Johnson Lane crosses through the Heart of Campus and is primarily a pedestrian-use area. This portion also is used by bicycles and service vehicles and for parking, with one-way south auto traffic. From Johnson Lane to 18th Avenue the axis is open to auto and bicycle traffic, with parking and sidewalks on the street edges in much the same manner as a typical city street. The axis provides a view of Lawrence Hall.

Form

For most of its length the axis is largely defined by the street, street trees, and sidewalks. For the portion north of 13th the axis is defined on its edges by pavement and regularly spaced trees and is completed by Lawrence Hall at the northern end. A majority of adjacent buildings have main entrances facing the street.

Pathways/Gateways

The sidewalks are heavily traveled along this axis. Numerous east/west axes intersect this axis, including 13th Avenue at the Heart of Campus and the pathway adjacent to the Amphitheater Green, both of which are heavily used pedestrian-activity areas. The Knight Library Axis crosses University Street to meet up with the Straub Green pathway leading to Straub Hall.

Trees/Landscapes

The Pin Oaks on the portion north of 13th Avenue are to be afforded extra care. Nearby significant trees include the Grand Fir on Collier House grounds and the Sitka Spruce on Collier House grounds and at the southwest corner of the Johnson Lane and University Street intersection. (Refer to the *Campus Heritage Landscape Plan and Survey of Historic Buildings and Landscapes*.)

Opportunities and Constraints

The axis, including the Heart of Campus at the intersection of 13th Avenue and University Street, is to be protected and enhanced. An effort should be made to introduce pedestrian-friendly designs (and de-emphasize the automobile). Refer to the University Street Study (2012) and the 13th Avenue Conceptual Design Study for more information.

Outdoor furniture and similar accessories intended to aid in the enjoyment of this area would be appropriate.

Recognize and maintain the nearby Free Speech Plaza at the Allen Hall south entrance.

(Refer to the Academic Center and Historic Core Diagnosis.)

GERLINGER ENTRANCE GREEN

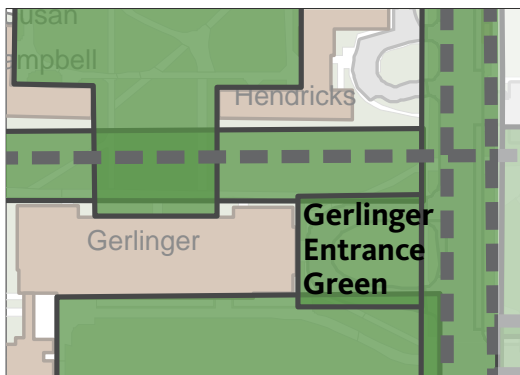

Current Use

The turnaround serves as a drop off for users of the building and contains some parking and service parking. This open space also preserves the view of the historic Gerlinger east entry façade, the entrance to Gerlinger Lounge.

Form

The turnaround is formed by the mature trees to the north and south, the trees along University Street, and Gerlinger Hall itself.

Pathways/Gateways

The University Street sidewalk along the east edge of the turnaround is a connection from the south campus area to the center of the campus. The Knight Library Axis defines the northern edge.

Trees/Landscape

The area is home to several mature trees along its edges. (Refer to the *Campus Heritage Landscape Plan and Survey of Historic Buildings and Landscapes*.)

Opportunities and Constraints

The area in front of Gerlinger Hall should be kept free of large trees to preserve views of the building and its entrance from University Street. Improvements along the edge of University Street that emphasize pedestrian movements are to be encouraged. Proposals should acknowledge that Gerlinger Hall is listed in the National Register of Historic Places.

(Refer to the South Central Campus Diagnosis.)

GERLINGER FIELD GREEN

Current Use

The field is used for instruction as an “Outdoor Classroom” and for passive recreation. It also preserves the view of the south façade of Gerlinger Hall, one of the most well-known views on campus. The path along the south side of the field serves as an important pedestrian and bike connection to Southwest Campus.

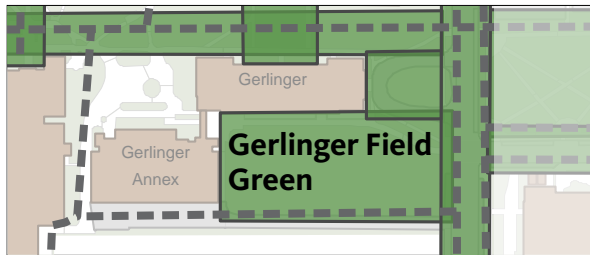

Form

The playing field is formed by Gerlinger Hall, Gerlinger Annex, and the trees edging the cemetery and University Street.

Pathways/Gateways

The designated bicycle and pedestrian route along the south edge of the field (part of the 15th Avenue bike route) is an important part of the east/west connection to Southwest Campus.

Trees/Landscape

The Douglas fir at the southeast corner of the field is a significant tree. Although not part of the open space, the conifers along the southern edge of Pioneer Memorial Cemetery contribute to the area’s character and are maintained by the university.

Opportunities and Constraints

This area shall be preserved as an Outdoor Classroom. The view of the south façade of Gerlinger Hall, which is listed in the National Register of Historic Places, shall be preserved as well. Overall, a better connection to University Street is desirable.

Pedestrian and bike access shall be preserved. Opportunities exist to work with the Eugene Pioneer Cemetery Association to make the area more appealing and safe.

(Refer to the Academic Center and Historic Core Diagnosis.)

FRANKLIN BOULEVARD AXIS

(See description in the Academics, Research, and Support Services, page 145)

Design Area

FRANKLIN TRIANGLE



Current Use

This area currently is used for parking. It is bisected by an access road that runs north south between Franklin Boulevard and East 11th Avenue. *(Verify potential restrictions for the access road).*

Area-wide Space Use Comments

Heavily devoted to parking, existing paths are not continuous or connected to campus, making pedestrian and bicycle circulation difficult. A significant historic structure, Dads’ Gates, is located across the street from the southern edge of this design area. Additionally, three large utility boxes related to the EmX bus rapid transit are located along the south sidewalk in the design area, and an EmX station is located adjacent to the design area in the center of East 11th Avenue.



The size of the Design Area is approx. 97,977 square feet. No Designated Open Spaces exist within the area boundaries.

Form

Separated from the main campus by East 11th Avenue, the area gets its triangular form from East 11th Avenue, Franklin Boulevard, and Kincaid Street. The area is clearly visible to a large and diverse public, making it important in communicating the beauty and presence of the university. The western campus edge of this design area at Kincaid Street and East 11th Avenue is undefined, as Kincaid Street does not connect through to Franklin Boulevard, and the northwest corner borders a portion of the Millrace waterway.

Pathways/Gateways

Because this area is separated from the campus by East 11th Avenue, new development should be limited to uses that do not encourage frequent crossings of that street, unless pedestrian access is improved. Because it is very visible from Franklin Boulevard, a major route to the campus, this design area has the potential to give a first impression of the campus and could become a primary gateway for pedestrians, bicyclists, and vehicles. The current sidewalk along the access drive that bisects the site was built to provide a safe and direct pedestrian connection from East 11th Avenue to the large private student housing development across Franklin Boulevard, where there is a traffic signal.

Trees/Landscape

There is an area of lawn and mature trees in the southeast portion of this design area. A mix of mature Oak and evergreen trees border the northern edge along Franklin Boulevard.

Opportunities and Constraints

Every opportunity should be taken to improve the visual qualities of this area. It is a good site for an academic building, assuming the pedestrian connection to campus is improved. For example, there may be an opportunity to acquire East 11th Avenue to create a pedestrian zone, and work with the City of Eugene to redirect East 11th Avenue automobile traffic (potentially via Kincaid street, in coordination with a future phase of the City of Eugene Franklin Boulevard Transformation Project). Such an opportunity would also allow for significant gateway improvements. The University will need to work with the city and engage with Bushnell University to address the current automobile access that bisects the site. Any new development should serve as a terminus to Dads' Gates Axis. Upon future redevelopment of the area, it will be important to maintain a safe pedestrian connection to the Franklin Boulevard crossing.

This design area is also a good location for a parking structure because of its proximity to major automobile routes, its proximity to a great number of campus users, and the possibility of developing parking at this site cooperatively with Bushnell University. Structured parking on the site should include the possibility of adding non-parking flexible uses to the ground level of the structure. Because of its very visible nature on an important route to the campus, a parking structure on this site would need to be designed in an attractive way using brick and other materials typical to the campus.

Projects should enhance the pedestrian character of the north end of the Dads' Gates Axis. Recognize the importance of Franklin Boulevard's western edge and of Dads' Gates Axis as a primary gateway to be improved to announce the university to all modes of transportation. Use tree plantings to expand on the Franklin Boulevard tree pattern.

The extension of the designated Campus Plan Pathway north across East 11th Avenue emphasizes

the need for a clear, strong, and safe pedestrian connection across East 11th Avenue to campus and desire to enhance the pedestrian character of the north end of the Dads' Gates Axis. Carefully consider views from Franklin Boulevard to this major gateway location.

Design Area PLC PARKING LOT

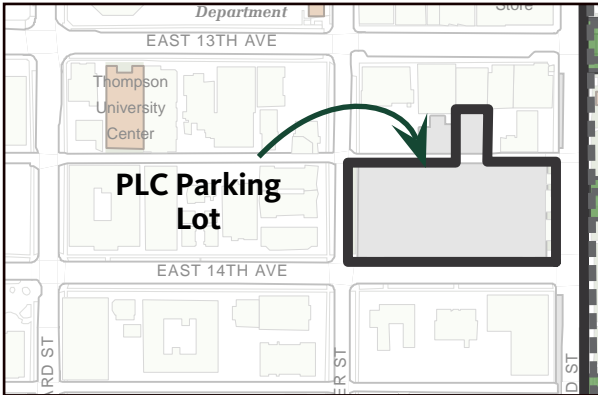

The size of the Design Area is 59,292 square feet. No Designated Open Spaces exist within the area boundaries.

Current Use

This area presently is devoted entirely to off-street parking. The South Kincaid LTD bus station is located on its eastern side.

Form

Formed by the streets and alley surrounding it, the parking lot occupies a strategic position as the western terminus of the east/west Johnson Lane Axis, which is anchored at the eastern end by the Erb Memorial Union. (Refer to a description of the Johnson Lane Axis on page 119.)

Pathways/Gateways

As noted above, this area is the western terminus of the Johnson Lane Axis. It is surrounded on three sides by city sidewalks.

Trees/Landscape

No notable or significant landscape features characterize the area.

Opportunities and Constraints

The proximity of this area to the campus core provides an opportunity for siting a major campus building. It should serve as an appropriate terminus of the Johnson Lane Axis and can potentially incorporate structured parking as a use. The bus transit station located on this site should be maintained and incorporated, a possibility to be explored in concert with Lane Transit District. This area is visible to the general public. Every opportunity should be taken to improve its visual qualities.

This area is adjacent to residentially-zoned land (refer to City of Eugene Land Use Code for potential restrictions).

Design Area

SOUTHWEST CAMPUS

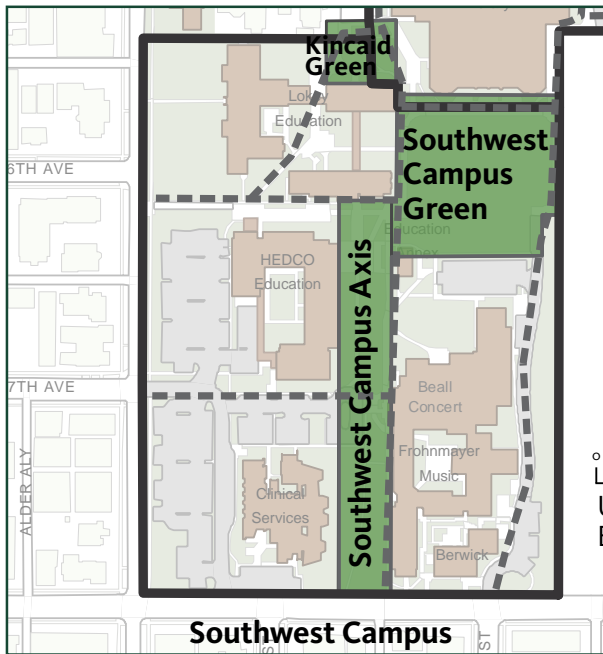

The size of the Design Area is 694,055 square feet. Approximately 22% is Designated Open Space.



This Design Area, identified as the Southwest Campus, includes facilities used primarily by the College of Education and the School of Music. A field space, the Southwest Campus Green, is situated in the area. Efforts to improve bike access through this area are encouraged.

Area-wide Space Use Comments

Consideration should be given to maintaining lounge and study spaces, including the small coffee bar, in proximity to major classrooms and lecture halls whenever possible, as suggested by the patterns “Small Student Unions” and “Student Workplace.”

Campus Edge: 18th Avenue and Alder Street/Kincaid Street

The 18th Avenue edge is adjacent to a high-density residential area. The street is classified as a minor arterial. Development along the 18th Avenue edge is highly visible to the public. Every opportunity should be taken to improve the visual qualities of this area. As redevelopment occurs in the southwest area of campus, visual clues (preferably through design features rather than signage) identifying the university and entry or parking routes are encouraged to convey a more positive image and to prevent autos from driving through the campus core and adjacent neighborhoods.

The Alder Street/Kincaid Street edge is adjacent to a medium-density residential area (zoned high-density residential). Although Alder Street is a single-lane road, it provides important auto, bike, and transit access to the university. Proposed development and changes in traffic patterns should take into consideration adjacent residential uses. Opportunities to enhance gateways and views into the campus, in particular Beall Hall, are encouraged.

Construction along Alder Street and Kincaid Street should consider the principles in the City of Eugene’s *West University Refinement Plan*.

KINCAID GREEN

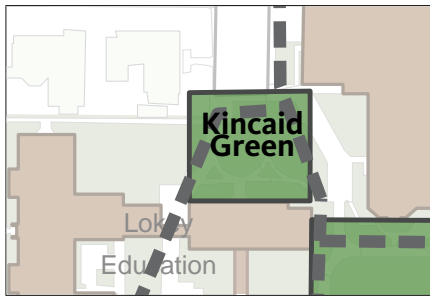

Current Use

This area at the terminus of Kincaid Street is a formal pedestrian entry to the Education complex. In addition it is the entrance to the Southwest Campus from the campus core. Two service-vehicle parking spaces also are located in this area.

Form

The most noticeable feature of this open space is a row of mature Douglas firs marking the terminus of Kincaid Street and the historic façades of the Education buildings.

Pathways/Gateways

The primary pathway is a heavily used pedestrian connection from the Southwest Campus to the academic core. This open space also contains part of the 15th Avenue designated bike path, which continues along the southern edge of Knight Library and on to University Street.

Trees/Landscape

The row of mature Douglas fir trees is a significant element of this part of campus. (Refer to the *Campus Heritage Landscape Plan and Survey of Historic Buildings and Landscapes*.)

Opportunities and Constraints

Proposals in this area should preserve and strengthen the open space by replacing the Douglas firs as they die and by preserving views of the Education building façade. An opportunity may exist to better define this terminus when the Douglas firs die, but additional work is required to define appropriate tree-planting options. The existing service area also presents challenges when considering improvements. Other improvements should be made to preserve and enhance the connections between the Southwest Campus and the main campus.

SOUTHWEST CAMPUS GREEN

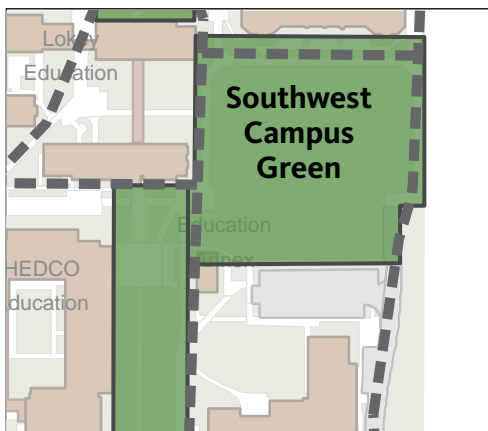

Current Use

This space accommodates informal recreational activities, formal gatherings, and the occasional class. It is the largest open and sunny space in the area. It also preserves the view of the south-facing Knight Library façade. The adjacent pathways serve as significant pedestrian and bike connections to the main campus.

Form

The area is purposefully open and sunny. It is formed by Knight Library to the north, the Education complex to the west, and Pioneer Memorial Cemetery's mature landscape (particularly the large Douglas fir trees) to the east. Its southern edge is not particularly well formed.

Pathways/Gateways

The north, east, and west edges contain important pathways that connect to the campus core. The northern edge of the space also is part of the 15th Avenue designated bike route.

Trees/Landscape

Significant trees in this area include the large Ponderosa pine at the northeast corner of the area and the large Douglas firs at the southeast corner. (Refer to the *Campus Heritage Landscape Plan and Survey of Historic Buildings and Landscapes*.)

Opportunities and Constraints

As the only large open and sunny space in the area, it is to be preserved. Proposals in this area should reinforce the southern edge of this space. The pathways should be preserved.

SOUTHWEST CAMPUS AXIS

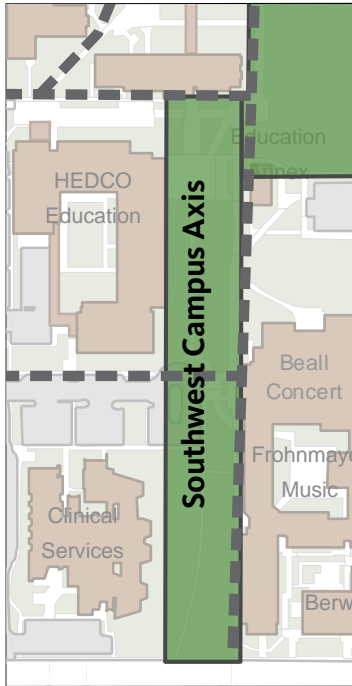

Current Use

The axis is used by pedestrians. The Beall Hall circle drive serves drop-off and delivery functions.

Form

The axis is a typical landscaped campus space, which opens to 18th Avenue on its south end. It is defined by the Music building to the east and the HEDCO and the Clinical Services buildings to the west. It terminates at the Education Addition at the north end. Primarily, main entrances face the axis.

Pathways/Gateways

The south end of this axis (18th Avenue) is an important pedestrian gateway and entry to the campus and the beginning of a pathway that leads along the length of the axis and eventually connects to the main campus. The area also has connections to Alder Street that serve as informal entries to the campus from the community.

Trees/Landscape

Important educational trees grow in the southern portion of the area. (Refer to the *Campus Tree Plan*, the *Campus Heritage Landscape Plan* and the *Survey of Historic Buildings and Landscapes*.)

Opportunities and Constraints

Future development plans for this area (for example, additions to the Music building) should include improvements to this axis to better define it. While preference should be given to pedestrians, opportunities for drop-offs and service access should be maintained. Pedestrian seating is to be included in future developments. Project proposals should preserve the view of the historic west entry to Beall Hall from Alder Street and enhance the view from 18th Avenue looking north. Opportunities to further enhance the gateway and public views along 18th Avenue should be pursued. Also, opportunities for gateways along and connections to Alder Street should be maintained and enhanced.

One small structure, Education Annex, which currently is occupied by the College of Education, is the original sales building for the Ellis Lawrence 1914 campus plan. It is largely intact, has been relocated twice, and should be preserved, although not necessarily in this location, as the area is developed.

The significant trees shall be preserved and should be afforded extra care.

Design Area

MILLRACE

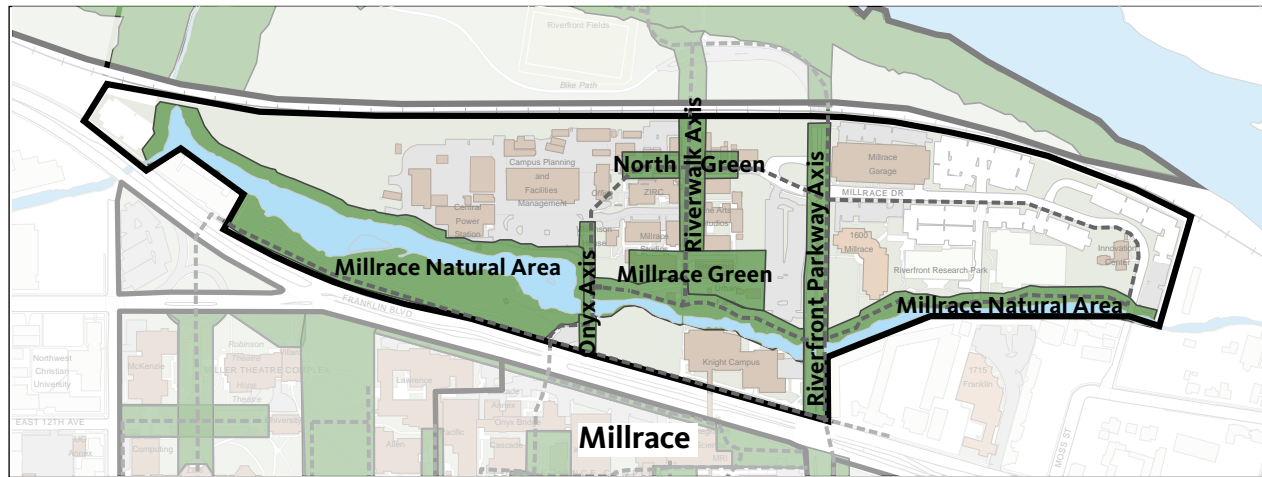

The size of the Design Area is 2,093,000 square feet. Approximately 36% is Designated Open Space.

This Design Area is home to the Phil and Penny Knight Campus for Accelerating Scientific Impact (Knight Campus), activities related to the College of Design, research functions, and administrative and support activities. Administrative and support activities include Campus Planning and Facilities Management (CPFM) with the Central Power Station, which occupies much of the area west of Onyx Street. Much of the land east of Riverfront Parkway was developed as part of the previous Riverfront Research Park and has long term ground leases. The Millrace flows through this area.

Area-wide Space Use Comments

This Design Area is intended to accommodate much of the university's anticipated future growth. However, Franklin Boulevard separates this area from the main campus. In order to minimize danger to pedestrians and bicyclists, programs located in facilities north of Franklin Boulevard should be primarily limited to those that do not encourage frequent crossings of this busy street (for example, two-hour to four-hour studio sessions are preferred over fifty-minute class sessions). Improved pedestrian and bike crossings would open up additional use opportunities.

An overall goal for this area is to ensure this area “feels” like a part of campus. Future development and improvements should celebrate unique features (Millrace) and uses, but be designed in a way that connects to campus (e.g. campus standard fixtures, open-space framework, similar building materials, etc.). Development must continue to protect and enhance the Millrace, a unique water feature in the area. In addition, special attention should be given to creating a safe and welcoming environment.

A city-approved Conditional Use Permit (CUP) and Willamette Greenway Permit (CU 18-1; WG 18-2) apply to a large portion of this area. The City of Eugene's Water Resources Conservation (/WR) Overlay Zone applies to land along the Millrace. The /WR overlay zone “protects significant riparian areas, wetlands, and other water-related wildlife habitat areas included on the City's adopted Goal 5 inventory.”

As opportunities arise, CPMF should continue to consolidate operations west of Onyx Street. Consider vegetative screening to buffer facilities related activities from adjacent areas. There is an opportunity for one non-facilities related building to the west of the Onyx Axis on a current parking lot. Refer to the CPMF/FASS Operations Center Programming and Conceptual Design Report. New vehicle access routes should be established from Riverfront Parkway and from Franklin Blvd over the Millrace at the west end of the CPMF area to reduce the use of Onyx Street

by service and delivery vehicles, thereby improving the pedestrian quality of this axis. Between the extension of Onyx Axis and Riverfront Parkway, development proposals for the area should further study the relationships to adjacent open spaces and circulation within this area to define designated open spaces. It is anticipated that uses within this area will primarily continue to support activities related to the College of Design, research, and the Knight Campus. The future building site at the intersection of Onyx Axis and Franklin Boulevard is suitable for a broader array of student-oriented uses linked to the main campus. Proposals for this area should consider the need to maintain adequate active open space for outdoor uses associated with the College of Design’s programs, including the Urban Farm, as these programs have been located in this area because certain uses are somewhat industrial in nature and may not be compatible with more traditional campus activities. The Urban Farm Outdoor Classroom should be preserved (See “Outdoor Classrooms” in “Principle 4: Space Use and Organization,” page 55). Proposals should carefully consider impacts to Urban Farm activities currently occurring outside of the designated Outdoor Classroom and consider replacing any displaced uses to support this unique and important academic program.

Completing an east/west service vehicle connection between Onyx Street to Riverfront Parkway will create a key route for service, delivery, and emergency access to the area. Specifically, the route will connect the existing service drive south of the Zebrafish International Resource Center to the intersection of Riverfront Parkway and Millrace Drive. When completed, the route will allow deliveries (especially those with large trucks) to serve new development and provide a route to the CPFM area from Riverfront Parkway. This, in turn, will significantly reduce vehicular congestion at the Onyx intersection, thus enhancing safety and the overall pedestrian and bicycle experience at this important crossing point and entry to the design area. The specific service route location should preserve the viability of future building sites and consider ways to integrate building service areas. Also, it should provide a safe route for bicycles traveling through this area. Particular attention should be paid to secondary pedestrian paths crossing this route.

The railroad along the north edge of the design area creates a physical barrier with limited opportunities to cross under. Impacts of the railroad (e.g. noise and vibration) will need to be considered for future development.

The area east of Riverfront Parkway will continue to be dedicated to a mix of research (university and private), university administration, and parking. Further evaluate the establishment of an open-space framework as ground leases expire and redevelopment opportunities arise.

Campus Edge: Franklin Boulevard

The University owns land on both sides of this busy boulevard, and development along the Franklin Boulevard edge is highly visible to the public. It is the primary automobile entrance to the university and often provides the first (and sometimes the only) impression of the university for visitors and the general public. Every opportunity should be taken to improve the visual qualities of this area and convey the university’s public role, mission, and history.

Continue efforts to convey the image of driving “through” rather than “by” the campus. This is evident with the development of the Knight Campus which established a significant university presence along the northern edge of Franklin Boulevard. The building-to-building bridge over Franklin Boulevard facilitates interactions between the faculty, staff, and students in the science buildings on the main campus and the Knight Campus. Further development adjacent to Franklin Boulevard should take advantage of the urban setting and improve the street edge through engaging façade designs (e.g., street-front entrances and windows). East of Onyx Street, building development should allow views “into campus” from Franklin Boulevard. West of Onyx Street, enhance views of the Millrace while screening the more industrial uses related to the Central Power Station and outdoor storage areas.

The City of Eugene’s Franklin Boulevard Transformation Project will transform Franklin from an

auto-focused state highway to a pleasant, multi-modal urban street that is safe for people walking, biking, riding the bus, and driving. Instead of being a divider between UO and the surrounding community, the boulevard will transform into a more comfortable connector of places. Proposals for this area should consider how future improvements along Franklin Boulevard will improve the experience and safety for all modes of transportation, especially pedestrians and bicycles crossing at the Onyx and Agate Street intersections.



MILLRACE NATURAL AREA

Current Use

The Millrace is a unique water feature on the north side of campus. Water levels fluctuate depending on the season, pumping capacity, and rainfall. Currently, the primary function of the Millrace is to convey stormwater. Existing vegetation (native and non-native) provide habitat and shade. The important pathway along its bank is used by pedestrians and bicyclists.

The west portion (west of Onyx Street) offers one of the most public opportunities to view and engage with this unique water feature as it is visible from Franklin Boulevard. Historically, this section of the Millrace was used for recreational activities. The mix of native and non-native plant species along the Millrace provides habitat and also functions to visually screen the CPFM area from Franklin Blvd. Past design/build projects by faculty and students from the College of Design (formerly Architecture and Allied Arts) include a wood deck overlook, stormwater bioswale, and seating.

The center portion (between Onyx Street and Riverfront Parkway) is adjacent to the Urban Farm. Recent improvements associated with the Phil and Penny Knight Campus for Accelerating Scientific Impact (Knight Campus) enhanced the Millrace by removing sediment, reshaping the channel and banks, and installing native plants. Two bridges provide pedestrian crossings over the Millrace. An existing structure, constructed as part of a past design/build project by students in the College of Design, is an attractive nuisance for transient activities.

The east portion (east of Riverfront Parkway) was developed as part of the former Riverfront Research Park development.

Form

The open space is natural in form, primarily defined by the Millrace and the associated landscaped areas. Also, it reflects the required Water Resources setback as defined by the /WR Overlay zone and acknowledged in the approved Conditional Use Permit. Unlike most open spaces, the edges are not defined by development.

Pathways/Gateways

A significant east/west bicycle and pedestrian pathway spans the length of this area. At the furthest west end the path leads to the signalized pedestrian crossing at the private student housing building, which provides a safe crossing of Franklin Boulevard eventually connecting to Dad's Gate and the academic core of campus. Important intersections exist where north/south paths intersect at Onyx Street, a significant pathway to main campus which is the primary crossing of Franklin Blvd for pedestrians and bicycles, and the north/south path in the Riverwalk Axis which connects Franklin Boulevard to the riverfront traversing over the Millrace pedestrian bridge and the railroad underpass. The pedestrian bridge that aligns with the Riverwalk Axis is an important connection to university development along Franklin Boulevard. At the east end the path connects to Millrace Drive.

Trees/Landscape

Native trees and shrubs along the Millrace, within the /WR Overlay zone, should be preserved. Non-native plants along the Millrace should be managed to promote native trees and shrubs. In the west section the existing Oaks along Franklin Boulevard are important street trees providing edge definition and habitat.

Opportunities and Constraints

Proposals for this open space should preserve and enhance the Millrace and riparian edge. Ongoing efforts to remove and manage non-native plant species should be implemented. Prioritize native plant species which provide habitat and enhance the Millrace. Proposals should consider providing access for activities associated with natural areas, for example bird watching, relaxation, and outdoor instruction. Refer to the recommendations contained in the Eugene Millrace Restoration and Enhancement report prepared by Pacific Habitat Services (2019).

The university-owned property, 901 Franklin, which is currently a parking lot, creates a unique opportunity to construct a bridge or crossing over the Millrace to provide a new service vehicle access to the CPFM area from Franklin Boulevard. This new vehicle access is important as it will reduce the need for service and deliveries at the Onyx Street intersection creating an opportunity to enhance the pedestrian and bike experience at the Onyx Street intersection.

In the east section, existing buildings adjacent to the Millrace Natural Area, with the exception of the Innovation Center, were developed with long-term ground leases as part of the Riverfront Research Park. Redevelopment in this area is not likely to occur until the leases expire. As redevelopment occurs additional development of an open-space framework is required.

Once the proposed east/west service/bike route is established in the Millrace Design Area, consider ways to shift bike traffic off the Millrace path, giving greater priority to pedestrians. Ensure coordination with the Eugene Transportation System Plan.

ONYX AXIS

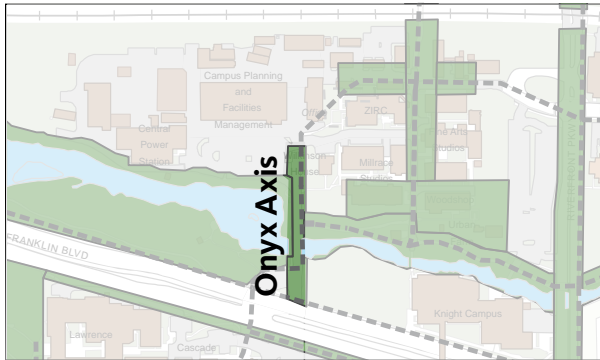

Current Use

Currently, Onyx Street is the primary access for vehicles, bicycles, and pedestrians to this part of campus from main campus and the riverfront path system. The Franklin Boulevard intersection provides a negative experience for pedestrians as there is limited room to wait comfortably for the traffic signal along with concerns about safety related to vehicle speeds. Sidewalks at the intersection are too narrow and parallel parking for cars create issues with clear site lines. The intent is to reduce vehicular use of this axis.

Form

The axis is defined by Onyx Street with no defined terminus on the north. Franklin Boulevard defines the south terminus.

Pathways/Gateways

This axis is currently, and will continue to be, the primary bicycle and pedestrian crossing of Franklin Boulevard and should be enhanced. It provides primary pedestrian and bike access to the Millrace area and riverfront path system.

Trees/Landscape

There are no existing trees or landscapes of significance in this open space. Existing large canopy trees along the axis should be preserved.

Opportunities and Constraints

As opportunities arise to provide alternative access for vehicles to the Millrace Design Area, the pedestrian nature of this axis should be enhanced. Reduction of vehicular use will be possible as parking lots transition to building development, and service and deliveries access to buildings, including Facilities Services, shifts to Riverfront Parkway and the proposed new east/west service route. Special attention should be given to enhancing the Franklin crossing to enhance pedestrian and bike safety and to create an attractive entrance to the area.

Activities associated with CPFM should continue to be consolidated west of the Onyx Axis. The parking lot west of Onyx and adjacent to the Millrace is a potential site for an academic or administrative building.

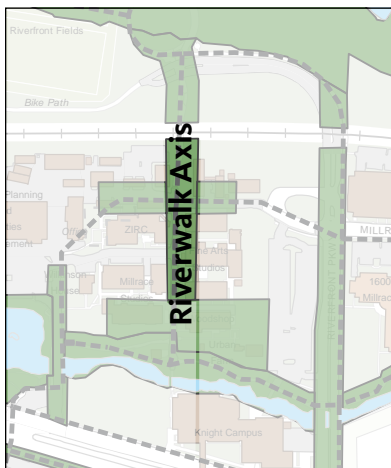

RIVERWALK AXIS

Current Use

This axis is a main route for pedestrians and bicyclists traveling from the multi-modal paths along the river, the Millrace, and connecting to the main campus. It is also the primary connector both visually and functionally, for pedestrians traveling from building to building, in particular the Fine Arts buildings. The axis accommodates service vehicles and drop-off parking and provides access to small parking lots within the North Campus Area.

Form

Currently, this axis is defined by low-scale buildings south of the underpass. As larger scale development replaces existing structures, carefully study the open-space width in proportion to the new buildings intended to further define the form of the axis on the east

and west. North of the railroad tracks the axis reflects the City of Eugene Land Use Code 9.3715(2) (e) which establishes a “setback of 50 feet on both sides of a straight line between the existing pedestrian underpass under the railroad tracks and the Autzen Stadium footbridge.” Consider opportunities to further define the axis with landscape features, such as flowering or large canopy trees, north of the railroad tracks.

Pathways/Gateways

This axis is a primary connector for pedestrians and bicyclists and links the Millrace path to the Frohnmayer Bridge over the Willamette River. The pathway within this axis is essential to connect the main campus to the Willamette River, downtown, Autzen Stadium, and the Ruth Bascom Riverbank Path System. Gateway opportunities exist at the railroad underpass. A pedestrian bridge over the Millrace connects the Riverwalk Axis to university development along Franklin Boulevard, providing an important connection.

Trees/Landscape

There are no trees of distinction within the axis. A coordinated effort should be made to further define the axis using large canopy or flowering trees while maintaining clear, open views through the axis.

Opportunities and Constraints

As buildings in the area are replaced south of the underpass further define the east and west edge of the widened open-space. This major pedestrian and bicycle connection should be enhanced with pedestrian-scaled lighting, seating, and express the unique character of activities in the buildings which line it. Service areas should be screened or moved away from this pedestrian access. The gateway, which is formed when the pathway dips under the railway tracks, should be enhanced. Pay particular attention to creating a safe, and welcoming experience at the pedestrian underpass.



RIVERFRONT PARKWAY AXIS

Current Use

The portion of the axis south of Millrace Drive is currently a local city street and is the primary public vehicle access to the northern part of campus including the parking structure. Limited vehicle access for service and maintenance is intended north of Millrace Drive. The jug-handle turn around facilitates service and delivery access to the Phil and Penny Knight Campus for Accelerating Scientific Impact (Knight Campus). This axis is heavily used by bikes and pedestrians as a route from the Willamette River to campus.

Form

The axis is defined by street trees on either side and in the median from the railroad underpass to the Franklin Blvd. Future development should help further define the form. The axis extends north beyond the railroad underpass to the Willamette Natural Area and is currently undefined. The south end terminates at Franklin Boulevard.

Pathways/Gateways

This is an important pedestrian and bicycle connection between campus and the riverfront path system, Frohnmayer footbridge, and Autzen stadium. The underpass at the railroad tracks serves as a gateway to the Willamette River. Vehicle traffic north of Millrace Drive is intended for authorized vehicles only for service, emergency, and future delivery access.

Trees/Landscape

The axis has established street trees and a landscaped median separating north and south bound traffic. This median provides the look and feel of a boulevard and should be retained. Other planting materials on either side of the access contribute to this feel as well.

Pay particular attention to the grove of trees north of the railroad underpass which the Conditional Use Permit requires to be preserved.

Opportunities and Constraints

Future development should contribute to and improve the pedestrian and bike friendly nature of the axis. Vehicle and service access associated with new development should be carefully planned to accommodate pedestrian and bicycle traffic along the axis.

On the north side of the railroad tracks, the axis currently contains the remnant of a street originally designed to serve high levels of automobile traffic. Now, this area is intended to serve exclusively service, or pick-up from and delivery to limited development. As opportunities arise and/or development occurs, reduce and reconfigure the street remnant to emphasize use by pedestrians and bicyclists and de-emphasize use by automobiles. Additional landscaping is encouraged to enhance the experience of entering the river's environments and provide opportunities for learning about this important and unique ecological area.

Creating a safe, welcoming, and accessible route to the river should be a primary goal of any proposal for this axis. Pay particular attention to the pedestrian and bicycle experience using the underpass.



MILLRACE GREEN

Current Use

This open space occupies land that is used by the Urban Farm (a designated outdoor classroom) and two buildings associated with the College of Design. Two bridges provide pedestrian crossings over the Millrace connecting this area to Franklin Boulevard and main campus. As redevelopment occurs, the intent is to provide an open sunny gathering place for this part of campus, while retaining the Urban Farm Outdoor Classroom.

Form

This open space is defined by the Millrace Natural Area to the south and the edge of the Urban Farm to

the east. The north and west edges are currently not defined and will be formed by future buildings.

Pathways/Gateways

An important north/south path extends through this open space connecting Franklin Boulevard to the riverfront traversing over the Millrace pedestrian bridge and connecting to the Riverwalk Axis and railroad underpass.

Trees/Landscape

The Urban Farm is a significant landscape feature in this open space and unique outdoor classroom for the campus. Pay particular attention to tree plantings to ensure a good mix of sun and shade is available within the green.

Opportunities and Constraints

This open space represents an opportunity to create a large open sunny gathering place and is intended to be the primary pedestrian open space for this part of campus. Future development should further define the edges and activate the green. Preserve and enhance passive and active recreation within the green. Provide open sunny spaces and pay attention to the unique attributes of the Urban Farm and Millrace. Give special attention to creating a safe and welcoming environment.



NORTH GREEN

Current Use

This green is currently not defined. It occupies space that is mostly a collection of smaller buildings, parking, and a roadway connection to the Riverwalk Axis and Riverfront Parkway.

Form

The open space will be defined by the existing Zebrafish International Resource Center and future buildings that will form its edges.

Pathways/Gateways

The Riverwalk Axis crosses through the open space.

The intent is to provide an east/west pedestrian connection.

Trees/Landscape

There are no existing trees or landscape features of significance in this open space.

Opportunities and Constraints

This open space represents an opportunity to create a campus-like open space in the Millrace Design Area. It is intended to be a pedestrian-scaled open space defined by future building development. Primary building entrances should face the green with service access at the rear or side. Proposed development in this area should carefully study and define the specific proportions of this open space.

Design Area

WILLAMETTE

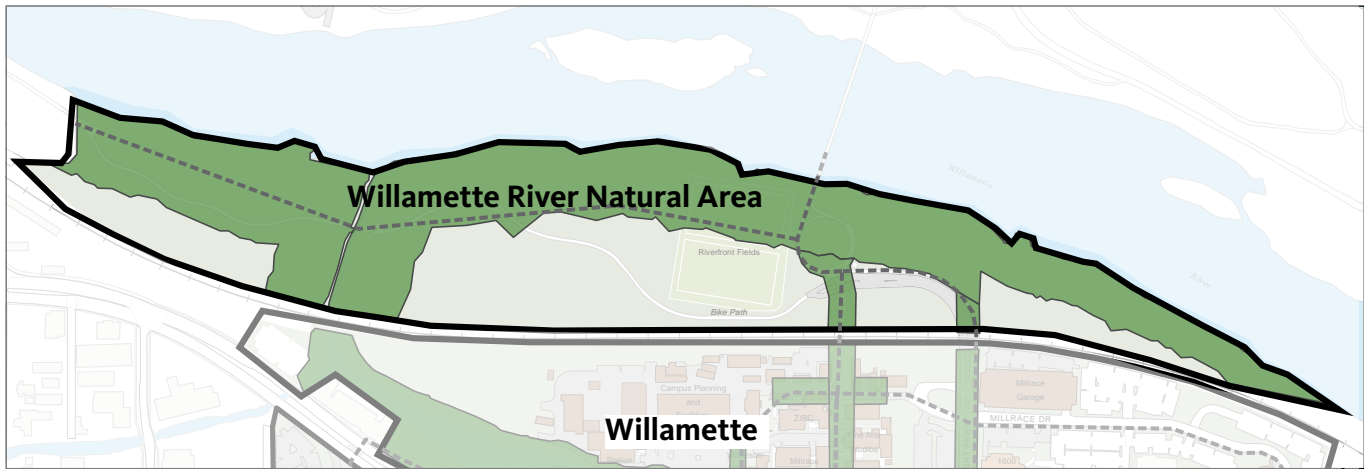

The size of the Design Area is 1,860,000 square feet. Approximately 60% is Designated Open Space.

The Willamette River is an important and special resource. This design area provides an opportunity for the university to showcase sustainability values while accommodating low intensity future development, recreational activities (passive and active), and safe access to the Willamette River.

Area-wide Space Use Comments

Development in this area should respond to the environmental and recreational context of the Willamette River and Millrace outfall and consider integrating innovative sustainable design principles, including a diverse palette of native flora.

This area includes land that was previously disturbed by industrial uses resulting in a significant amount of fill material throughout the site and a steep riverbank making access to the river difficult. Historical uses included large scale resource extraction and manufacturing, including gravel mining, an asphalt and concrete plant, and a utility storage yard. Much of the design area has been minimally managed, primarily with periodic mowing, and allowed to be re-vegetated reflecting a somewhat natural state. Several different remnant habitats exist and most of the trees are native, although significant amounts of invasive plant species are present throughout the area. West of the Millrace outfall there are remnants of past industrial uses throughout the site.

This area currently supports outdoor instruction and research for a variety of academic courses, recreation fields which are designated as Outdoor Classrooms, and a variety of recreational activities. Recreational activities should be located to provide safe access to the river and accommodate a wide range of activities, which support physical and mental health. Recreation fields should be located along the railroad tracks outside of designated open-spaces to accommodate enhancements to the riparian and upland area along the river. Consider opportunities to showcase urban agriculture and other uses that reflect the academic mission of the university. Priority should be given to building uses related to opportunities and functions of the ecological and recreational setting. Proposals should consider innovative ways to showcase forward thinking environmental design solutions and material selection while meeting programmatic needs. All storm water from development sites should be treated prior to discharging into the Willamette River or Millrace. Special attention should be given to creating a safe and welcoming environment.

A city-approved Conditional Use Permit (CUP) and Willamette Greenway Permit (CU 18-1; WG 18-2) applies to the entire area. Proposals must be consistent with the Conditional Use Permit, which enables several land uses, and be responsive to university needs. The City of Eugene's

Water Resources Conservation (/WR) Overlay Zone applies to land along the Willamette River and Millrace Outfall. The /WR overlay zone “protects significant riparian areas, wetlands, and other water-related wildlife habitat areas included on the City’s adopted Goal 5 inventory.” The approved CUP prohibits buildings or new recreation fields within the Riparian Enhancement Setback, which is 200 feet along much of the river top of bank. Ensure coordination with the City of Eugene Transportation System Plan when developing the area west of the Millrace Outfall.

Campus Edge: Willamette River

The Willamette River is the 13th largest river, by volume, in the United States¹⁴ and, along with the associated riparian area, serves as critical habitat for a variety of flora and fauna. University land which abuts the Willamette River provides a unique and special opportunity for an urban river experience which enhances the academic and student experience. The current edge condition is considerably different than natural river edge conditions due to historic industrial use and large amounts of subsequent fill. The university is uniquely positioned to increase access for outdoor instruction and river-related recreation while improving ecological functions of the river and associated riparian and upland habitat using restoration techniques. Consider projects that improve the ecological functions and return portions of the river’s edge to a more natural condition.

As stated in the Riparian Assessment and Management Report by Mason, Bruce, and Girard (2018): “The portion of the Willamette River within the campus boundary contains many of the morphological components necessary for a healthy river ecosystem. These components include pools and riffles, gravel bars, seasonally exposed vegetated benches, large woody debris, mud flats, fringe wetlands, boulder clusters, and backwater and side channel habitat. These components along the Willamette River provide habitat and forage for a wide array of native fish species (both resident and anadromous) for all life stages expected to occur in the river.”

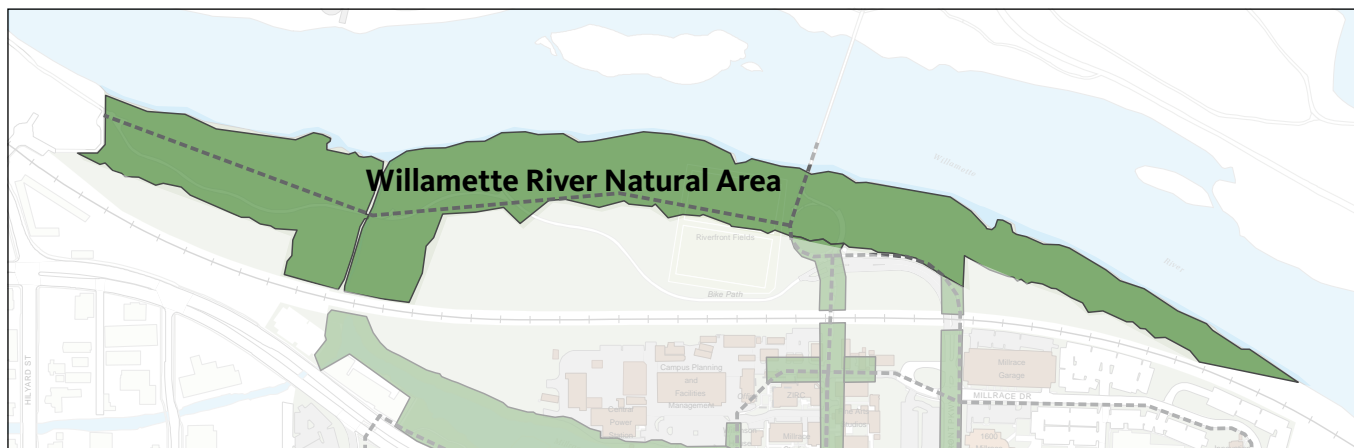

WILLAMETTE RIVER NATURAL AREA

Current Use

This area currently includes large amounts of open space with both native and invasive plants, the Millrace outfall, a segment of the City’s Ruth Bascom Riverbank Path System, undeveloped river access, and a portion of the Riverfront Fields and associated chain-link fence. Transient activity, including at times camping, is prevalent. The river and associated riparian and upland habitat is a destination for students and faculty for outdoor instruction and research. Although river access is generally undeveloped, when water levels are low exposed bedrock offers opportunities for swimming and enjoying the river environment.

¹⁴ <https://willamette-riverkeeper.org/basicfacts>

Form

The natural area is formed by the Willamette River, Millrace, and areas defined as the Required Conservation and Riparian Enhancement Areas within the approved Conditional Use Permit (CUP). Refer to the approved CUP for specific definitions, located here: <https://cpfm.uoregon.edu/north-campus-conditional-use-permit-cup>. The CUP's Riparian Enhancement Setback extends beyond the City of Eugene Water Resources conservation setback requirements with the intention to enhance ecological functions, provide increased habitat, allow for enhanced outdoor instruction, and support passive recreation.

Pathways/Gateways

The South Bank Path, which is part of the City's Ruth Bascom Riverfront Path System, provides a significant pedestrian and bike connection between the university, downtown, and entire community. The path is located in an easement granting the City access to build and maintain the path. Recently approved improvements will realign the western portion of the path to improve safety as well as add pedestrian scale lighting along the entire path. In an agreement with the City, campus standard light fixtures will be installed to reinforce the university's identity in this part of campus.

The City of Eugene's Frohnmayer Bridge crossing the Willamette River serves as a gateway into campus for pedestrians and bicyclists coming from the north (Autzen Stadium, Eugene parklands, and private student housing north of the river) and is a unique opportunity for extended views up and down the river. Maintaining views to this crossing is important.

There are a number of unimproved foot paths throughout the area, which provide access to the river and Millrace.

Trees/Landscape

A 2012 ecological survey identified over 200 plant species throughout the Willamette Design Area. Approximately 1/3 of the plant species are native and the majority of trees are native. To the greatest degree possible preserve native trees and shrubs along the river and in upland areas with the understanding that some removal be necessary to implement large scale riparian area restoration, path realignment, or other enhancement projects. Refer to the CUP for stands of trees that should be preserved. Prioritize removal of invasive species and replace with native plants providing habitat for a diverse array of species. Manage plantings to discourage camping and allow for views of the river. Conduct additional investigation to determine existing wetland or sensitive plant communities in the area west of the Millrace outfall (former EWEB pole yard), which contains several small depressions created from years of soil compaction from industrial use which display unique ecological characteristics.

Opportunities and Constraints

Proposals in this area should preserve and enhance the natural environment along the Willamette River and Millrace and be consistent with the approved Conditional Use Permit. Pay particular attention to riparian areas which include ecologically significant features, which are vital components to aquatic health and provides a unique opportunity for students to study and learn from the natural environment. In conjunction with improvements to the riparian area, safe access should be provided to appropriate areas along the river. Unimproved foot paths should be discouraged to minimize human impacts within the natural area. Currently, the river bank is unnaturally steep because of imported fill, making access to the river difficult. Consider large scale projects to lay back the banks to a more natural condition. Enhance access to the river for outdoor instruction and recreation (i.e., walking, biking, swimming, and personal paddle craft launching) using materials and in a manner that is appropriate in a natural area. Consult professional experts in the field of riparian restoration and river hydrology to provide design and implementation recommendations. Incorporate strategic locations for views of the river and riparian area.

Future adjacent development should locate main entrances and facades facing the river to optimize

views of the natural area and river. Service and parking (to the degree allowed per the CUP) should be located along the railroad tracks and screened from the natural area as much as possible.

Existing recreation fields and associated fences should be relocated out of the designated open space and further from the river to accommodate enhancements to the riparian and upland area along the river. Buffer adjacent development, for example with plantings and topography in the adjacent upland area, to minimize impacts to the riparian area along the river. Proposals for adjacent building development and recreation fields should carefully consider options for materials which balance program needs and impacts to the natural landscape and river. For example, for any proposals for recreational fields, natural turf is the first choice. Also, carefully consider how landscape features, for example fencing, lighting, seating, etc., contribute to a welcoming campus environment while respecting the natural setting. For example, proposals for field lighting should implement the most up-to-date technology to minimize light spill and glare, and consider a lighting schedule to minimize impacts to wildlife and the riparian area along the river. Consider opportunities to locate art or sculptural elements within appropriate areas, such as the circular area near the Frohnmayer Bridge. Future opportunities to realign the path (associated with the relocation of existing playing fields) is encouraged to locate the path within the designated open-space to create a user experience which relates to the river, supports habitat restoration efforts, and aligns with potential recreational and development activities.

Pathways that cross under the railroad tracks, such as within the Riverwalk Axis and Riverfront Parkway Axis, should be preserved and enhanced. Attention should be given to the view to and through these crossings. Lighting and landscaping should enhance the pedestrian experience while minimizing light spill into ecologically sensitive areas. The South Bank Path provides an important bike and pedestrian-oriented connection between the university, the Downtown Riverfront development, and downtown to the west. Where the South Bank Path enters university land, there is an opportunity to celebrate and recognize this as a campus gateway. Campus standard furnishings, including a map station, should be used to reinforce the university identity. Future projects should consider ways to further reinforce the sense of arrival to campus from the



RIVERWALK AXIS

(See description in the Millrace Design Area for the Riverwalk Axis)



RIVERFRONT PARKWAY AXIS

(See description in the Millrace Design Area for the Riverfront Parkway Axis)

Design Area

NORTHEAST CAMPUS (ACADEMICS, RESEARCH, & SUPPORT SERVICES)

**Area-wide Space Use Comments**

Most of the university's facilities devoted to supporting research and instruction in the sciences are located in this area. Oregon Hall, a student services and administrative building, also is located in this area.

Campus Edge: Franklin Boulevard

The university owns land on both sides of this busy boulevard, and development along the Franklin Boulevard edge is highly visible to the public. It is the primary automobile entrance to the university and often provides the first (and sometimes only) impression of the university for visitors and community members. Every opportunity should be taken to improve the visual qualities of this area and

convey the university's public role, mission, and history.

University ownership on both sides of the boulevard gives an opportunity to convey the image of driving "through" rather than "by" the campus.

Clear visual clues (preferably through design features rather than signage) identifying the university and entry or parking routes are essential. Previous gateways improvements at Agate Street and Onyx Street are examples.

Open-space and landscape elements and views into campus should be preserved, as well as pedestrian access on both sides on the boulevard, as development occurs. The university edge is a respite from the commercial development along Franklin Boulevard.

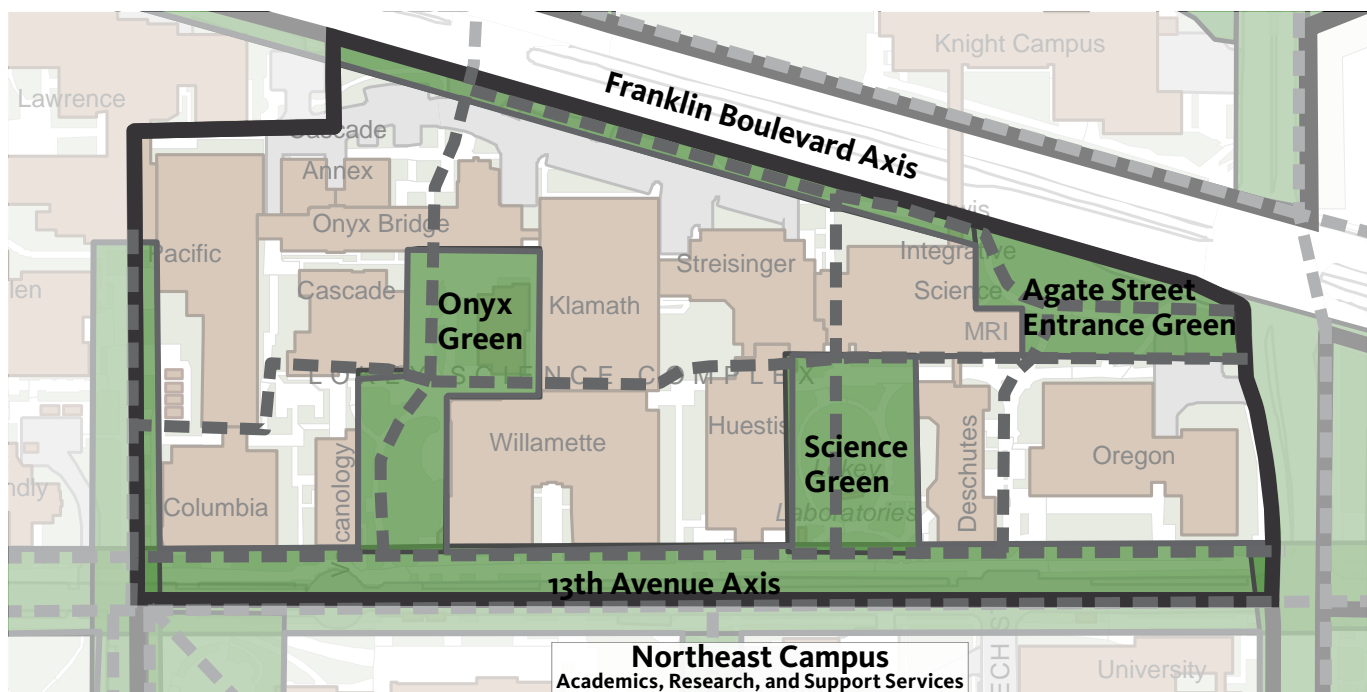

The size of the Design Area is 580,363 square feet. Approximately 36% is Designated Open Space.

13TH AVENUE AXIS: UNIVERSITY STREET TO AGATE STREET

(See description in the Academic Center and Historic Core Design Area for the Kincaid Street to University Street portion of this axis, page 117; and the Student Housing Design Area for the Agate Street to Moss Street portion, page 160)

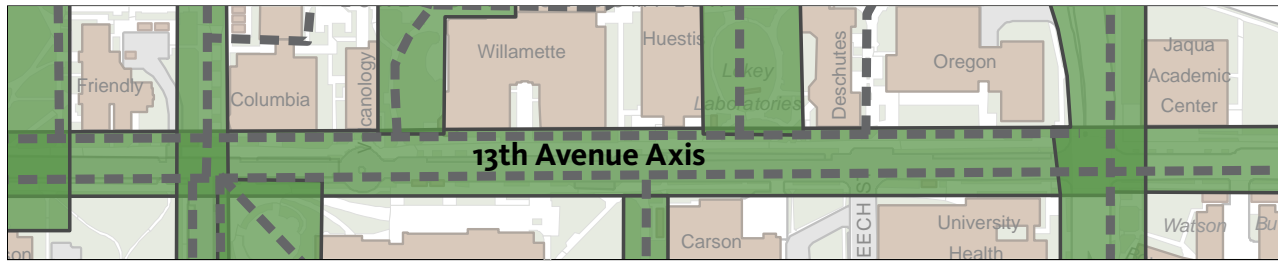

Current Use

The easterly portion of the axis, between Agate Street and Volcanology, functions as a typical street with two-way car traffic, parking on one side, sidewalks on both sides, and bicycles moving among the cars. For the portion west of Volcanology, the axis is closed to auto traffic and is used by pedestrians, bicyclists, and service vehicles much like the portion of 13th Avenue west of University Street.

Form

This portion of the 13th Avenue Axis has the character of a typical tree-lined street. Its edges are formed by the fronts and sides of the adjacent buildings. Most of these buildings have front doors facing the street. The Heart of Campus project at 13th Avenue and University Street introduced pedestrian-friendly design elements and restructured the street at Volcanology to discourage traffic from continuing through to University Street. (Refer to “University Street Axis,” page 121, for more information). This axis intersects the Science Green and a number of other axes.

Pathways/Gateways

This axis is a major east/west pedestrian and bike pathway connecting residential uses to the east with the center of the campus to the west. The intersection of Agate and 13th is a poorly defined gateway to the campus leading to confusion among visitors finding their way to the campus. An important north/south pathway through Onyx Green and to North Campus begins at this axis just east of Volcanology. A number of other north/south pathways intersect this axis.

Trees/Landscape

Large-canopy deciduous trees, consisting primarily of Red oaks and Pin oaks interspersed with other deciduous trees, line the street. The Douglas fir at the 13th Avenue intersection is of special significance. It grew from a seed that was among four fir seeds carried to the moon aboard Apollo XIV in 1971 by Astronaut Stuart Roosa.¹⁵ This area contains important educational trees, including the two Shagbark Hickory trees on Beech Street (Refer to the *Campus Heritage Landscape Plan and Survey of Historic Buildings and Landscapes*.)

Opportunities and Constraints

As a public institution, the university needs to be welcoming and open to the public. Many visitors’ first impressions are formed as they pass through the intersection at Agate and 13th, and plans for development or improvements need to respond to this opportunity. Efforts should be coordinated with improvements in the following two Design Areas: Northeast Central Campus (Academics, Student Services, and Housing); and Student Housing. Design strategies that further encourage bikes and pedestrians and discourage auto traffic (with the exception of service vehicles) are supported. An opportunity to establish north/south connections to 15th Avenue from this axis are

¹⁵ In 1978 the seedling was planted where Willamette Hall now stands; it was transplanted in 1987 to accommodate construction of the additions to the science complex.

to be explored as the Northeast Central Campus (Academics, Student Services, and Housing) Design Area is developed or redeveloped. Other opportunities for connecting to open spaces or axes in the Academics, Student Services, Housing Design Area from this axis are to be explored as well.

Refer to the *University Campus East Gate Feasibility Study* (1999) and the *13th Avenue Axis Conceptual Design* (2019) for additional information.

Approaches to the intersection of 13th Avenue and Agate Street, as well as the intersection itself, are particularly important in this respect.

(Refer to the Northeast Campus Diagnosis.)



ONYX GREEN

Current Use

This space, which contains a plaza, is primarily a pedestrian zone, although a major bicycle path cuts through it. In addition, the east/west Science Walk passes through this open space.

Form

The area's northern portion is defined by Onyx Bridge and Klamath, Cascade, and Willamette Halls. Within this designated open space is the Price Science Commons, a glass pavilion entry space that provides access to the underground library. The portion to the south is defined by Willamette Hall on the east and Volcanology on the west.

Pathways/Gateways

The pathway running through this space connects 13th Avenue to Franklin Boulevard and is an important north/south connector for bicycles and pedestrians alike to North Campus. The Onyx Green is one of the first campus spaces many view when coming to the campus. The Science Walk, an important east/west connection, runs along the plaza's southern edge.

Trees/Landscape

A large Dawn redwood grows in this area near the Cascade Hall entrance. This important campus tree is recognized by the Eugene Tree Foundation as a heritage tree. It is one of two Dawn redwoods planted on campus from the original seed shipment from China.

Opportunities and Constraints

The replacement of buildings that form the edges of the plaza (in particular Onyx Bridge) must provide for the continuation of the pathway and bicycle connections to Franklin Boulevard. Building replacements may slightly adjust the plaza's shape, but should not significantly reduce its size.

The Dawn redwood is to be preserved. Opportunities to enliven the plaza are encouraged.

Opportunities to establish a campus gateway at Onyx Street should be considered.

(Refer to the Northeast Campus Diagnosis.)

SCIENCE GREEN

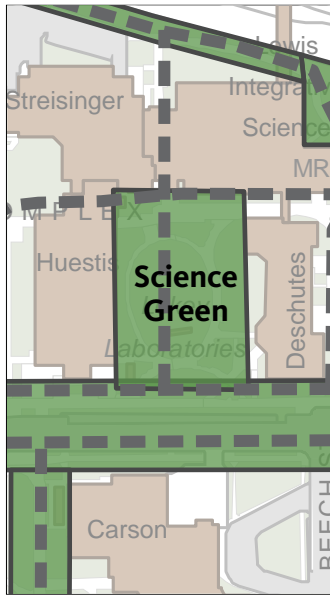

Current Use

This space is primarily pedestrian-oriented. Open, sunny, grassy areas and seating provide space for informal use and formal gatherings (such as graduation ceremonies).

Form

The space is formally developed with symmetrically placed sidewalks. Buildings define the east, west, and north edges of the green, which is open to 13th Avenue on the south. Main building entrances open into this space.

Pathways/Gateways

The southern end of the space connects to 13th Avenue, an important east/west pathway. The Science Walk is on the northern edge. This pathway is an important link that parallels 13th Avenue and carries pedestrians through the Lokey Science Complex. It connects Agate Street to the University Street Axis. Much of the Science Walk is identified by special paving created as part of the State of Oregon's One Percent for Art Program. A pedestrian link to the Franklin Boulevard Axis is provided through the Lewis Integrative Science Building.

Trees/Landscape

The trees that have been planted in the last fifteen years contribute to the formal nature of the space.

Opportunities and Constraints

Proposals for development in this area should preserve and strengthen the Science Green and should maintain a connection to the Franklin Boulevard Axis (through the Lewis Integrative Science Building), the Science Walk, and 13th Avenue. Main entrances to buildings on the green are to be reached directly from the green and not from the 13th Avenue Axis or the Science Walk. Special attention should be given to artwork, including the Science Walk paving and sundial.

(Refer to the Northeast Campus Diagnosis.)

AGATE STREET ENTRANCE GREEN

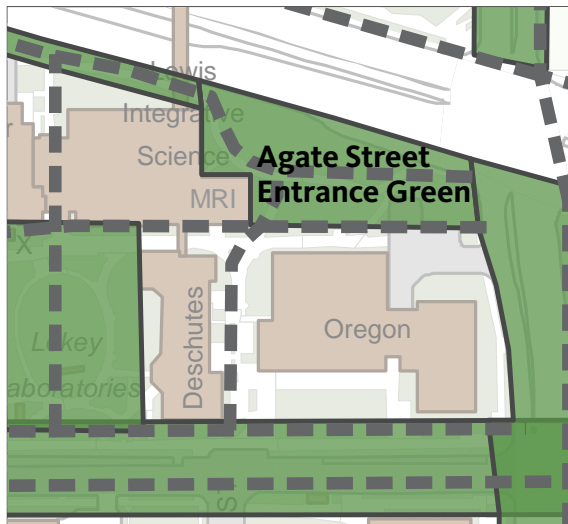

Current Use

This area surrounds the large sign identifying the University of Oregon. It is used by pedestrians and bikes, and the sign is used often as a backdrop for photographs of visitors, graduates, and new students. This area serves as an extension of the Franklin Boulevard Axis.

Form

The area is formed by the street edges, the sign, and its associated landscaping.

Pathways/Gateways

Agate Street is the main automobile entrance to the campus and as such is one of the major gateways to the university.

This area contains a primary pedestrian and bike pathway that extends along Franklin Boulevard (refer to Franklin Boulevard Axis below). It connects to the campus core via the Science Walk (see also “Science Green” on page 144), the pathway between Deschutes and Oregon Halls and the Agate Street sidewalk.

Trees/Landscape

The trees that frame the sign contribute to its visual qualities and are an important image-generating feature for the university. The two large red oak trees are also significant.

Opportunities and Constraints

This area is dedicated to identifying the university. It is very visible to the public, so every effort should be made to enhance its visual qualities and portray a positive university image through form, materials, and character. While it is desirable to buffer parking and service areas, open-space and landscape elements should enhance views into campus whenever possible rather than serve as buffers. Also, every effort should be made to protect the two significant red oak trees.

If the sign is relocated, it should be in clear view from both directions to the greatest degree possible. The sign should not block significant views into campus or pedestrians’ and bicyclists’ views along the pathway.

(Refer to the Northeast Campus Diagnosis.)

AGATE STREET AXIS: FRANKLIN BOULEVARD TO 15TH AVENUE

(See description in the Northeast Central Campus--Academics, Student Services, and Housing--Design Area, page 153.)

FRANKLIN BOULEVARD AXIS (also refer to the description of the Campus Edge: Franklin Boulevard, page 141.)

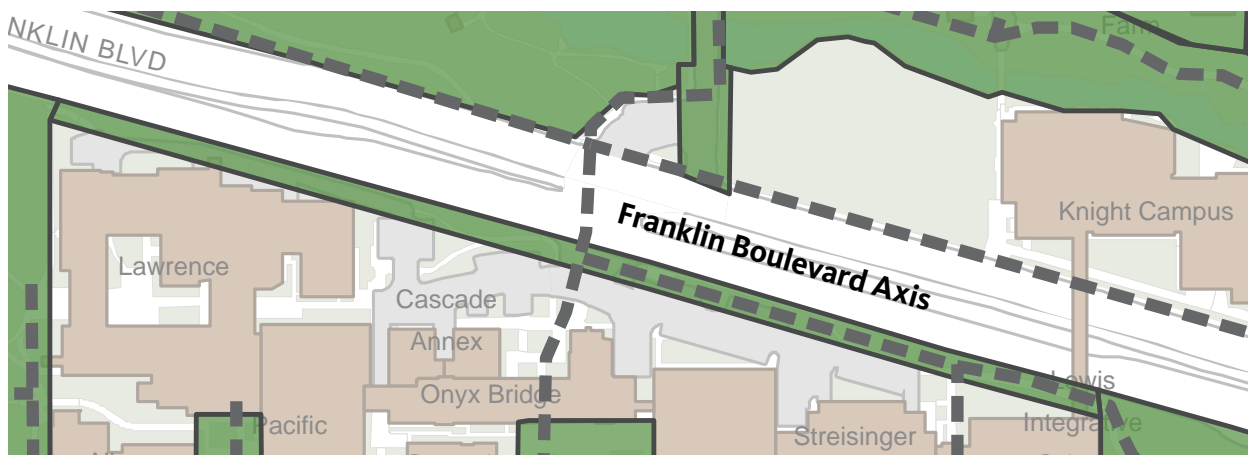

Current Use

This landscaped area serves as an important public view corridor and conveys the campus image. It usually provides the first and sometimes only impression of the university for visitors and community members. It is intended primarily for pedestrian and bicycle use. Portions of adjacent parking and service areas project into this open space. It is adjacent to Franklin Boulevard. Franklin Boulevard is used heavily by automobiles and serves as the primary automobile access to the university.

Form

This open space is formed by the street edge, the pedestrian/bicycle pathway, and landscaping. Although it is considered an axis due to its linear nature, buildings do not define its edge in a typical axial fashion; rather they serve as a backdrop.

Pathways/Gateways

Franklin Boulevard is the main automobile entrance to the campus (via Agate Street).

This axis contains a primary east/west pathway for pedestrians and bicyclists traveling to and through the university. This pathway continues east along Franklin Boulevard through the Agate Street Entrance Green and west along the northern edge of the Old Campus Quadrangle. Intersections with pathways at Onyx Street, the Science Green (through the Lewis Integrative Science Building), between Deschutes and Oregon Halls, among others, provide access into campus.

No established mid-block Franklin Boulevard pedestrian crossing exists; however, pedestrians cross mid-block creating an informal and unsafe connection to North Campus.

Trees/Landscape

This axis is informally lined with a mix of coniferous and deciduous trees, some of which are the only on-campus example of a species. The Himalayan pine is of particular note (it is also used for educational purposes).

Opportunities and Constraints

This area is highly visible to the public. Every opportunity should be taken to improve its visual qualities and convey the university's public role, mission, and history. The university's edge should serve as a green respite from the commercial development along Franklin Boulevard. While it is desirable to buffer parking and service areas, open-space and landscape elements should enhance views into campus whenever possible rather than serve as buffers. Pay particular attention to noted trees.

Ensure that development does not create a "wall" of buildings along Franklin Boulevard. Unlike most open spaces, buildings should not define the edge of this open space, which parallels Franklin Boulevard. A stepped form of development, interspersed with pathways and larger open spaces that provide access and views into campus, is more appropriate. University ownership on both sides of the boulevard gives an opportunity to convey the image of driving "through" rather than "by" the campus. Consider expanding designated open-space boundaries to accomplish this. Opportunities to establish a campus gateway at Onyx Street should be considered.

Preserve and enhance pedestrian and bike access along Franklin Boulevard. Also preserve pedestrian access into campus and enhance it when opportunities arise (for example, along the east side of Klamath Hall). An informal Franklin Boulevard pedestrian crossing is not encouraged unless a viable way to create a safe crossing is provided.

Clear visual clues (preferably through design features rather than signage) identifying the university and entry or parking routes are essential. Previous gateway improvements at Agate Street and Onyx Street are examples.

(Refer to the Northeast Campus Diagnosis.)

Design Area **NORTHEAST CENTRAL (ACADEMICS, STUDENT SERVICES, & HOUSING)**



This Design Area includes a mix of academic uses, student services, residential halls, and related active and passive open spaces.

This area provides an opportunity for the development of a major gateway to the campus at the intersection of Franklin Boulevard and Agate Street. Plans for improvements should respond to that opportunity. Refer to the *13th Avenue Conceptual Design Study (2019)* for additional information.

New Designated Open Spaces (active and passive) in this area may occur in conjunction with development. Development projects shall ensure an adequate balance between development and open space and shall maintain

and expand north/south connections from 13th Avenue to 15th Avenue. Redevelopment of existing residence halls in the area, particularly Walton Hall, also may result in the designation of additional or replacement open spaces. North/south connections from the Promenade (see below) to 13th and 15th Avenues should be considered. Refer to “Principle 2: Open-space Framework,” page 37, for detailed information about the creation of Designated Open Spaces.

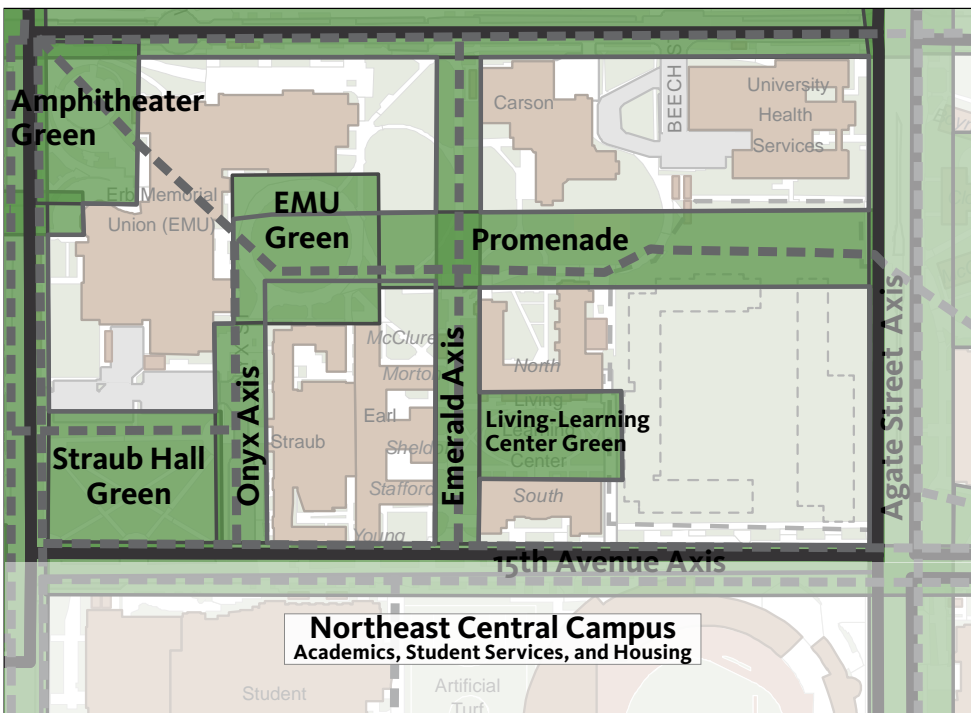

Existing recreational spaces, both active and passive, are essential elements and are to be preserved and, wherever possible, enhanced.

Area-wide Space Use Comments

Primary responsibility for building space use and development planning for the Erb Memorial Union and the surrounding open space rests with the Erb Memorial Union administration and Board of Directors. In addition to review processes established by this Plan, proposals for development in this area surrounding the EMU are to be reviewed by the Erb Memorial Union Board of Directors. This

The size of the Design Area is 1,016,396 square feet. Approximately 37% is Designated Open Space.

principle does not extend to proposals regarding the Straub Hall Green.

Primary responsibility for building space use and development planning of the residence halls rests with the University Housing department.

Historically, residence halls have been converted to non-residential uses when the need for central campus academic space has warranted such a conversion. No provision of this Plan should be construed to preclude re-dedication of residence halls to other purposes, provided that sufficient provisions are made for accommodating the demand for residence hall occupancy. Unless otherwise determined by the president, “sufficient replacement” means replacement on a bed-for-bed basis.

13TH AVENUE AXIS: UNIVERSITY STREET TO AGATE STREET

(See description in the Northeast Campus--Academics, Research, and Support Services--Design Area, page 142.)

UNIVERSITY STREET AXIS: 13TH AVENUE TO 15TH AVENUE

(See description in the Academic Center and Historic Core Design Area, page 121.)

AMPHITHEATER GREEN

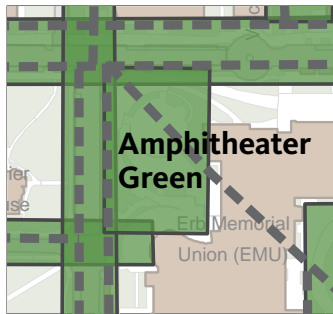

Current Use

This space was created to serve primarily as an open and sunny formal and informal gathering place. The free speech platform was established in 1962 by President Fleming. As a link between the Heart of Campus to the Promenade, it carries a large amount of pedestrian traffic.

Form

The form of this space comes largely from the west and north façades of the Erb Memorial Union and from the contoured levels within the green itself.

Pathways/gateways

An important pathway runs through this space connecting the Heart of Campus to the Promenade. The adjacent pedestrian walkways on University Street and 13th Avenue also are very important.

Trees/Landscape

No significant trees are contained within the green. It is primarily a hardscape designed with open views to accommodate heavy use and multiple venues. Surrounding the outer edge of the amphitheater are flagpoles from the Native American Tribes of Oregon Flagpole Project (2012). (Refer to the *Campus Heritage Landscape Plan and Survey of Historic Buildings and Landscapes*.)

Opportunities and Constraints

This active open space (including the designated free speech platform) is used for a wide variety of entertainment and social venues and should be preserved. Any work in this area is subject to review and approval by the EMU Board of Directors in addition to the usual Campus Planning Committee review. The pathway between the Heart of Campus and the Promenade should be preserved. The adjacent pathways should not be impeded.

STRAUB HALL GREEN

Current Use

This quiet green serves only pedestrians.

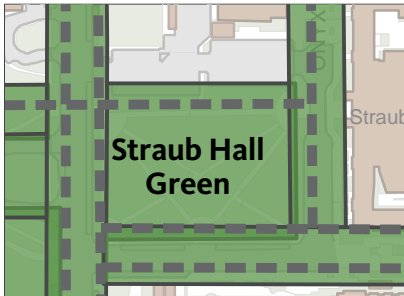

Form

The expanse between Straub Hall and University Street has a traditional campus character with informal plantings of deciduous and coniferous trees in a lawn setting. The main building entrances of Straub Hall and the Student Recreation Center face the green.

Pathways/Gateways

Pedestrian walkways criss-cross the green, which has a mix of sunny and shady seating areas. The east/west pathway along the northern edge connects with the Knight Library Axis to the west.

Trees/Landscape

This land formally was part of the Stafford farm; unique plantings from the farm remain on this site. Trees of significance include a Big Leaf Maple, Coast redwoods, as well as Douglas fir street trees. (Refer to the *Campus Heritage Landscape Plan and Survey of Historic Buildings and Landscapes*.) Some of the trees also are identified as important educational trees, including the young Monkey Puzzle tree which is the only example of its type on campus.

Opportunities and Constraints

Proposals in this area should preserve and strengthen the Straub Hall Green. Future tree plantings should buffer the open space from the EMU parking area and continue to shade the west side of Straub Hall. Refer to the *University Street Study* (2001) for additional information.

ONYX AXIS

Current Use

This axis functions as a low-traffic volume street and a parking lot with two-way vehicular traffic, sidewalks, and bicycles. Although it is not a through street, it provides service vehicle access to the Earl Hall service area and the EMU loading dock, vehicle access to the parking lot south of the EMU, bike access to EMU, and Straub Hall bike parking.

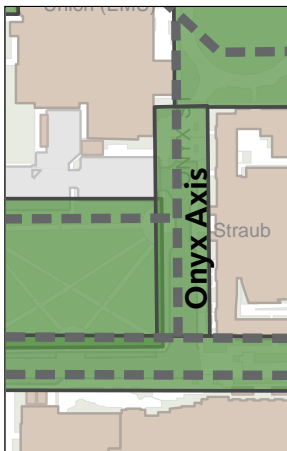

Form

This axis has the character of a typical tree-lined street. Its eastern edge is formed by the front façade of Straub Hall, and the western edge is formed by a row of large conifer street trees.

Pathways/Gateways

This axis contains a north/south path that links the Promenade and the EMU to 15th Avenue and the Student Recreation Center. It also intersects with the east/west path along the north edge of the Straub Quadrangle.

Trees/Landscape

This axis is lined with deciduous trees on the east side and primarily mature conifers on the west side. Some of these are significant educational trees or the only on-campus example of a species. (Refer to the *Campus Heritage Landscape Plan and Survey of Historic Buildings and Landscapes*.)

Opportunities and Constraints

As an important north/south pedestrian link, this axis should be preserved and enhanced. Design strategies that further encourage pedestrians and discourage vehicle traffic (with the exception of service vehicles and parking needs related to research in Straub Hall) are supported. Planters and bollards at the intersection of 15th Avenue and Onyx Street help provide a safe pedestrian crossing in this area. Significant trees should be afforded extra care. Maintain and enhance the pedestrian crossing that connects to the east/west path along the north edge of the Straub Quadrangle.

EMU GREEN

Current Use

This space was created to serve primarily as an open and sunny space for formal and informal gatherings. With the exception of Earl Hall service area access, this area is used exclusively by pedestrians.

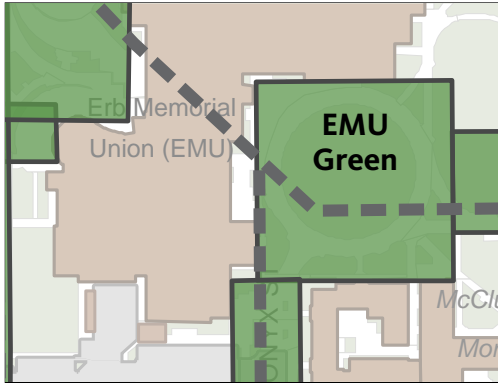

Form

The form of this grassy space comes largely from the east and south façades of the EMU and the north façade of Straub Hall. One of the EMU's primary entrances (at the northern corner of the east facade) faces the open space. Secondary building entrances also face the open space.

Pathways/Gateways

This space is bisected by an important pedestrian pathway that passes through the EMU. The pathway links the academic core west of the EMU (via the Amphitheater Green and Heart of Campus) to the mostly residential areas of campus east of the EMU (via the Promenade). It also intersects with the north/south Onyx Axis.

Trees/Landscape

No significant trees are contained within the Green.

Opportunities and Constraints

Proposals in this area should preserve and strengthen the character and active use of this Green. Future EMU expansion should help define the eastern edge. Future open-space improvements should preserve the intentionally open and sunny space, which is designed to accommodate a wide variety of activities and events. Efforts to enhance the EMU south entry and plaza are encouraged. The pathway, which passes through the EMU and connects the Heart of Campus to East Campus, should be preserved and enhanced. The adjacent pathways should not be impeded.

Any work in this area is subject to review and approval by the EMU Board of Directors in addition to the usual Campus Planning Committee review.

PROMENADE

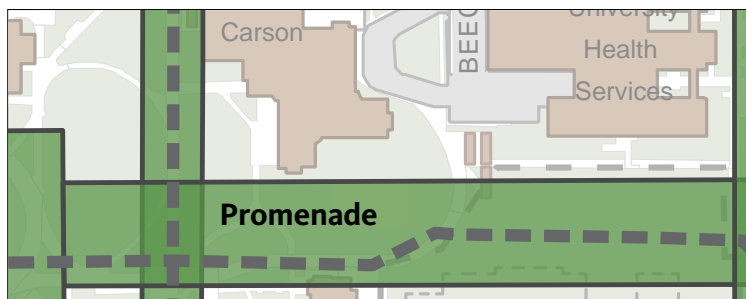

Current Use

The Promenade is heavily used by pedestrians and by residence hall occupants for outdoor activities.

Form

The Promenade has an open, informal character. It passes through an intentionally sunny open area dotted with shade trees and is not particularly well formed by buildings.

Pathways/Gateways

This promenade contains an important pathway that links the academic core west of the Erb Memorial Union to the mostly residential areas of campus east of the Erb Memorial Union. Its eastern end connects the campus core to East Campus. (Refer to "Agate Street Axis: Franklin Boulevard to 15th Avenue," page 153.) The pathway is not intended for bike use.

Trees/Landscape

Trees in this area are arranged to create a mixture of sunny and shaded zones. There is a nice collection of deciduous trees in the area including red oaks and a variety of magnolias. (Refer to the *Campus Heritage Landscape Plan and Survey of Historic Buildings and Landscapes*.)

Opportunities and Constraints

The Promenade should be preserved as a major pedestrian pathway, and proposals in this area should preserve and strengthen it. Open space and pedestrian connections between 13th Avenue and 15th Avenue should be defined and enhanced. In particular, the redevelopment of the residence halls in the area may offer opportunities for new connections and open spaces. (Refer to the introductory section for this Design Area, page 147.)

Existing recreational spaces, both active and passive, are essential elements and are to be preserved and, wherever possible, enhanced. New or replacement trees could be used to enhance pathway intersections and building entrances.

EMERALD AXIS

Current Use

This axis is an exclusive pedestrian-use zone for movement between 13th and 15th Avenues.

Form

It is a narrow space flanked on the southern portion by Earl Hall Complex to the east and the Living-Learning Center to the west. The northern portion is less well defined.

Pathways/Gateways

This axis contains a portion of a north/south pathway that links 13th and 18th Avenues. It intersects the Promenade.

Trees/Landscape

This area is partially lined with American sweetgums and other deciduous large-canopy trees. The Douglas fir at the 13th Avenue intersection is of special significance. It grew from a seed that was among four fir seeds carried to the moon aboard Apollo XIV in 1971 by Astronaut Stuart Roosa (refer to the 13th Avenue Axis: University Street to Agate Street, page 142 and to the *Campus Heritage Landscape Plan and Survey of Historic Buildings and Landscapes*.)

Opportunities and Constraints

As an important north/south link, this axis should be preserved if or when changes to the open spaces are made in concert with remodeling the EMU or redeveloping Earl Hall.

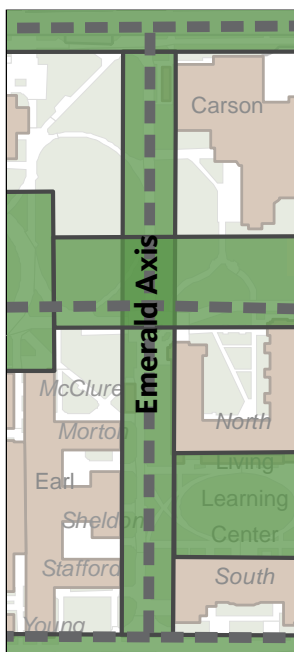

LIVING-LEARNING CENTER GREEN

Use

This pedestrian area is used primarily by residents of the Living-Learning Center for informal recreational activities.

Form

It is formed by the two portions of the Living-Learning Center on the north and south, Earl Hall Complex to the west, and Walton Hall Complex to the east.

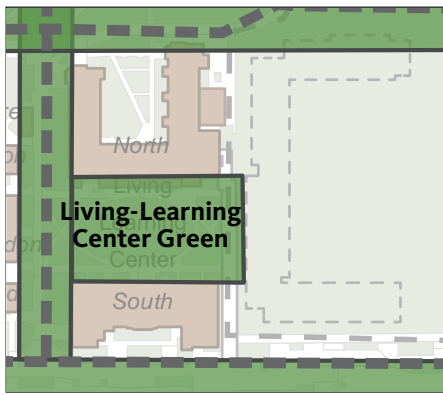

Pathways/Gateways

The western edge of this space is crossed by the Emerald Axis, an important north/south route in the area. The less defined pathway along the eastern side connects 13th Avenue to 15th Avenue via Beech Street. It serves as a designated bike route and provides service access.

Trees/Landscape

The area was designed to be sun filled and contains only a few small trees.

Opportunities and Constraints

If Walton Hall Complex is redeveloped or the ground floors of Earl Hall Complex are remodeled as classrooms, this green may become an important link between the west and east parts of the campus and eventually to the larger open-space framework on the green's east side. Efforts to enhance the pedestrian use of the pathway on its eastern edge connecting 13th Avenue and 15th Avenue are encouraged.

15TH AVENUE AXIS: UNIVERSITY STREET TO AGATE STREET

(See description in the Student Housing Design Area for the Agate Street to Villard Street portion of this axis, page 162.)

Current Use

This axis is an important connection from main campus to East Campus. The 2018-20 Hayward Field Renovation Project implemented a new design for the majority of this axis. The portion between Onyx Street and Agate Street is now an exclusive zone for pedestrians, bicyclists, and authorized vehicles (i.e., service and delivery for student housing, shuttles, and ADA). This section of 15th Avenue experiences high pedestrian traffic, especially during athletic events at Hayward Field. The portion from University Street to Onyx Street still functions as a traditional street with two lanes of traffic, side street parking, and heavily used sidewalks on both sides. It is a designated bicycle route, and bicycle traffic mixes with autos. The intersection of University Street and 15th Avenue is a busy multi-modal intersection used by personal and service vehicles, bicyclists, and pedestrians.



Form

At its western end the axis intersects with University Street. The western portion is formed on one side by the entrance terrace to the Student Recreation Center. Form is also given by the covered bicycle racks and entrance

landscape fountain of the recreation center. To the north of the recreation center are the Straub Hall Green with large conifers that line the axis and the southern side of Straub Hall itself, which helps to form the northern edge of the axis. From Onyx to Agate streets, the axis is clearly formed by landscape beds that line both sides of the axis and a mix of deciduous and coniferous uniformly planted street trees (installed as part of the 2018-20 Hayward Field Renovation project). Form is also provided from the fencing along the recreation fields, the Living-Learning Center, and the rebuilt Powell Plaza and Hayward Field Stadium. A rebuilt Powell Plaza at the intersection of 15th Avenue and Agate Street acts as a gateway and a main entrance to the stadium.

Pathways/Gateways

The 15th Avenue Axis is an important pedestrian and bicycle connection to East Campus. Design elements at the intersection of Agate Street (implemented as part of the 2018-20 Hayward Field Renovation Project) clearly establish a pedestrian and bicycle zone. The design creates a feeling of entering into an area that is prioritized for non-motorized traffic, rather than a traditional auto-

oriented street design. These elements include landscape paving materials, plantings, and bollards that control access. This axis connects to an important pathway that crosses through the athletic fields in the Southeast Campus (Academics, Athletics, and Recreation) Design Area and terminates at 18th Avenue. (See page 155 for more information about this pathway.) It also connects to the pathways in the Emerald Axis and University Street Axis.

Trees/Landscape

At its western end the large, mature trees in the Straub Hall Green line the axis. The axis also benefits from trees planted in the landscaped islands and a mix of planted coniferous and deciduous street trees along the pedestrian axis. (Refer to the Campus Heritage Landscape Plan and Survey of Historic Buildings and Landscapes.)

Opportunities and Constraints

The 2018-20 Hayward Field Renovation Project strengthened the definition of the axis and created a pedestrian and bicycle focused environment from Onyx to Agate streets. The landscape beds lining both sides of the axis are inset islands from the exterior edges, creating three pedestrian walking areas: main center, right side, and left side. The landscape pavers add human scale and texture to the axis.

Opportunities to extend the pedestrian and bicycle zone further east should be explored, prioritizing non-motorized traffic. And, the multi-modal intersection at University Street should be improved.

Opportunities to better connect this axis to the 13th Avenue Axis should be explored and implemented as redevelopment of this Design Area occurs.

AGATE STREET AXIS: FRANKLIN BOULEVARD TO 15TH AVENUE

(See description in the Southeast Campus Design Area for the 15th Avenue to 18th Avenue portion of this axis, page 157.)



Current Use

Agate Street, owned by the city and classified as a minor arterial, is used heavily by vehicles, pedestrians, and bicycles. Many visitors who are driving enter the campus by turning onto Agate Street from Franklin Boulevard. Also, it is an important pedestrian link between the main campus and East Campus, particularly along the western edge of the Student Housing Design Area, and at the mid-block crossing on Agate Street. There are critical event functions that occur on 13th Avenue related to the Matthew Knight Arena during events, such as bus staging.

Form

In addition to the typical street configuration (two lanes of vehicle travel with sidewalks and bike lanes), it is noted for its landscaped center median. Much of its form comes from its mature street trees, particularly along the western edge of the axis. Along the east, the edge of the axis is reinforced by a number of building facades (including the Jaqua Center and the Phase One Residence Hall Building) which are aligned with one another and set back from the street. Along the west, the axis is also reinforced by several buildings (Oregon Hall and the University Health, Counseling, and Testing Center).

Pathways/Gateways

The intersection of this axis with Franklin Boulevard is the major vehicular entrance to the university campus. The pedestrian crossing midway between 13th Avenue and 15th Avenue is a critical element of pedestrian travel linking main campus to the eastern residential areas and the entire East Campus Area. While the functioning of the mid-block pedestrian crossing may be addressed further as the city studies changes to the operation of the street, having convenient

and safe mid-block crossings like this continue to be essential to campus and are consistent with the city's Vision Zero Action Plan (<https://www.eugene-or.gov/4270/Vision-Zero>). Pedestrian crossings at the intersections of 13th and 15th Avenues also are important. The 15th Avenue and Agate intersection is growing in importance both for pedestrian and bicycle traffic due to nearby development. *(For more information about the 15th Avenue intersection, see description in the Southeast Campus Design Area for the 15th Avenue to 18th Avenue portion of this axis, page 157).*

Trees/Landscape

The Agate Street Axis has the character of a typical tree-lined street. It is lined in a formal arrangement with large-canopy deciduous trees consisting mostly of American sweetgums, Scarlet oaks, and American elms interspersed with other deciduous trees. The canopy is enhanced by a tree-lined median between 13th Avenue and 15th Avenue.

Opportunities and Constraints

Proposals in this area should preserve and strengthen the Agate Street Axis and acknowledge that this area is highly visible to the public. Every opportunity should be taken to improve its visual qualities and convey the university's public role, mission, and history. Further enhancement of the axis through buildings and tree canopy is desirable to improve the appearance of the primary gateway to the university, to help connect East Campus to central campus, and to shade the street surface. The motorist's view of pedestrian crossings should not be impeded. (Refer also to the *2003 Development Policy for the East Campus Area* and to the *Northeast Campus Diagnosis*.)

Proposals in this area should acknowledge the importance of the intersections at Franklin Boulevard, 13th Avenue, the mid-block crossing, and 15th Avenue. Pedestrian crossing enhancements should be considered, especially at the intersection of 13th Avenue and Agate Street, which is controlled by 4-way stop signs. Heavy peak travel times of pedestrians and vehicular traffic often result in congestion and/or long wait times for vehicles, bikes, and pedestrians (refer to the *13th Avenue Conceptual Design Study*). *(For opportunities at the intersection of Agate Street and 15th Avenue, refer to the Agate Street Axis: 15th Avenue to 18th Avenue, page 157. For opportunities at the intersection of Agate Street and Franklin Boulevard, refer to the Franklin Boulevard Axis description, page 14.*

Design Area **SOUTHEAST CAMPUS (ACADEMICS, ATHLETICS, AND RECREATION)**



This large “superblock” includes buildings, fields, stadiums and other outdoor spaces dedicated primarily to instructional and recreational athletics as well as competitive and training activities for intercollegiate athletics. The outdoor fields, located at the center of this superblock between Hayward Field and the Student Recreation Center, are used as Outdoor Classrooms and recreation/athletics space.

Area-wide Space Use Comments

The large open spaces situated within this area are required to meet the demand of instructional programs, as well as the recreational needs of students. These open spaces serve as Outdoor Classrooms and are essential university resources to be managed in a way that maximizes their benefit to the university community as a whole. They should not be considered as available building sites simply because they are open spaces. New buildings or the expansion of existing buildings in this area are to be sited in ways that preserve field spaces of usable size

and shape. In addition, the north/south pedestrian and bicycle pathway from 15th Avenue to 18th Avenue, and the east/west midblock pedestrian pathway from Agate Street to University Street, should be preserved. The pathway character is less formal, in keeping with the adjacent recreational fields. The area will include more academic uses with the redevelopment of McArthur Court. Refer to the Framework Vision Project (FVP) and the University Street Feasibility Study (2012) for additional information about the potential expansion of the open-space framework in the Esslinger Hall and Mac Court area with academic/support structures and consideration of a new underground parking garage that is close to core campus functions.

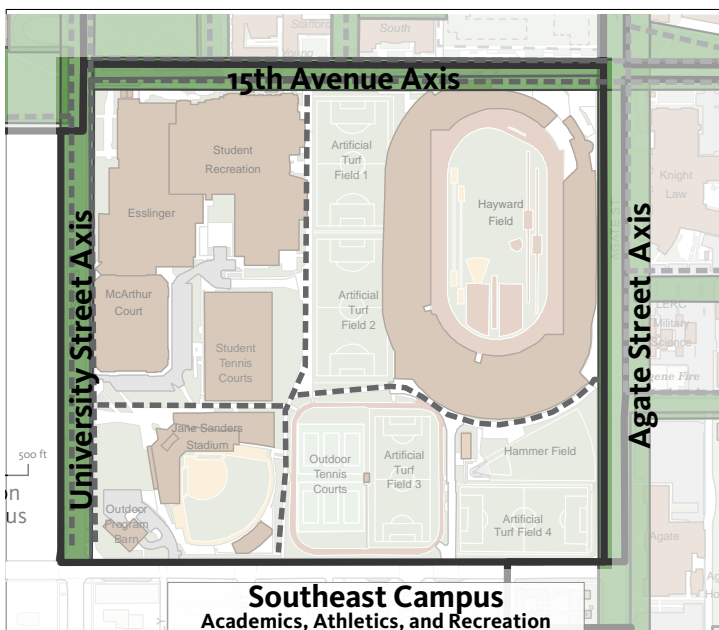

Campus Edge: 18th Avenue

The 18th Avenue edge is adjacent to a high-density residential area with public vehicular access. The street is classified as a minor arterial. Development along the 18th Avenue edge is highly visible to the public. The open character of this edge allows unencumbered views of active recreation and athletic fields, a positive and unique image for campus. Every opportunity should be taken to improve the visual qualities of this area, maintaining the majority of open views of the recreation and athletic fields. It is unlikely that development of buildings will occur along 18th Avenue because it is reserved for outdoor athletics and recreational uses with the exception of the Outdoor Program Trip Facility and its possible replacement with a larger academic/support structure

The size of the Design Area is 1,515,345 square feet. Approximately 12% is Designated Open Space.

(refer to the Framework Vision Project (FVP) for this area). Improvements to this area should take advantage of the unique potential to highlight university activities to the public. In addition there is an opportunity to improve the pedestrian entrances, especially at University Street and at the mid-block pedestrian path. Outdoor lighting should be compatible with adjacent residential uses. The intersections of Agate and University Streets are primary gateways to campus from the south into the heart of campus for pedestrians, bicycles, and private vehicles. Consideration should be given for opportunities to improve these intersections, especially the entrance to campus at the intersection of 18th Avenue and University Street, through use of physical design elements such as formal tree and decorative plantings, signage, wider pedestrian walks, and way-finding elements (E.g. a map station).

15TH AVENUE AXIS: UNIVERSITY STREET TO AGATE STREET

(See description in the *Northeast Central Campus--Academics, Student Services, and Housing--Design Area* page 151, noting in particular the pathway within the Emerald Axis, which continues through this Design Area.)

UNIVERSITY STREET AXIS: 15TH AVENUE TO 18TH AVENUE

(See description in the *Academic Center and Historic Core Design Area for the Lawrence Hall to 15th Avenue portion of this axis, page 121.*)

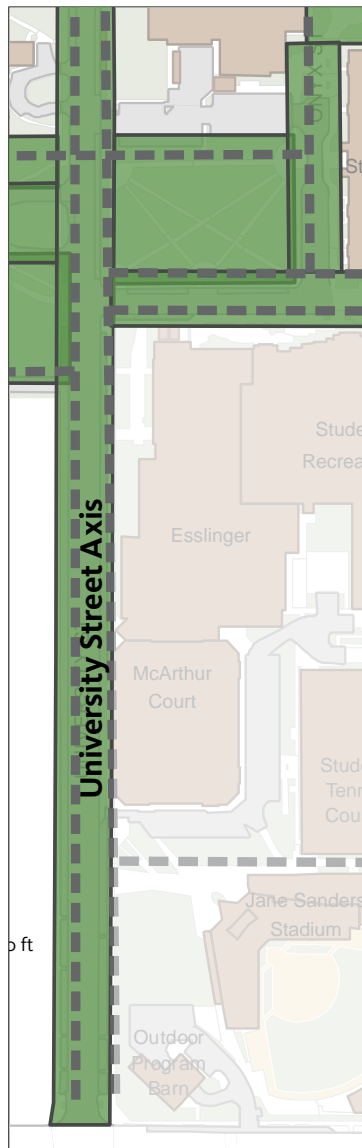

Current Use

The portion of the University Street Axis from 15th to 18th Avenues is used by cars, bikes, and pedestrians. It also is used heavily for car parking. The parking is especially useful to users of the Student Recreation Center on 15th Avenue.

Form

This axis is a typical street with sidewalks and curbs. It gets some form from the mature trees along its western edge in Pioneer Memorial Cemetery and from McArthur Court on its eastern edge.

Pathways/Gateways

As a public institution, the university needs to be welcoming and open to the public. The southern end of this axis has a gateway marking the connection between the public and the university. This gateway is made with plantings and pylons. The street is a designated bike path.

Trees/Landscape

The English oaks in front of Esslinger Hall help define the axis. Newer trees in street planters help shade the street. Trees associated with the Pioneer Cemetery help define the axis edge. (Refer to the *Campus Heritage Landscape Plan and Survey of Historic Buildings and Landscapes.*)

Opportunities and Constraints

Proposals in this area should preserve and strengthen the University Street Axis, in particular the campus entrance at 18th Avenue. Future development must include provisions for pedestrian use of the axis. Development of the axis along the western edge should address cemetery access and safety in coordination with the Pioneer Memorial Cemetery board of directors. Also, take advantage of the opportunity to reestablish the coniferous tree plantings that once defined the eastern boundary of the cemetery. The adjacent area

will include more academic uses with the redevelopment of McArthur Court, and a potential new underground parking garage that is close to core campus functions and replaces parking removed from University Street.

The intent of expanding the open-space framework in the area is to punctuate University Street

with a series of engaging outdoor rooms that relate to future proposed new buildings, and create a connection to help reclaim a significant portion of University Street for pedestrians and bicyclists.

New buildings and main entrances should be sited to frame open spaces, and foster pedestrian activity. Reinforce the intersection of 18th Avenue and University Street as a formal southern gateway into the heart of the campus. Refer to the University Street Feasibility Study (2012) for additional information about the potential expansion of the open-space framework in the Esslinger Hall and Mac Court area.

AGATE STREET AXIS: 15TH AVENUE TO 18TH AVENUE

(See description in the Northeast Central Campus--Academics, Student Services, and Housing--Design Area for the Franklin Boulevard to 15th Avenue portion of this axis, page 153.)

Current Use

Agate Street, classified as a minor arterial, is owned by the city and is used heavily by vehicles, pedestrians, and bicycles. Many visitors enter the campus by turning onto Agate Street from Franklin Boulevard. As the only north-south road that transects the campus, Agate Street offers users a more intimate view of the campus than other streets, due in part by the level topography, slower vehicle speeds, frequent stops, and the campus users who walk along and cross the street.

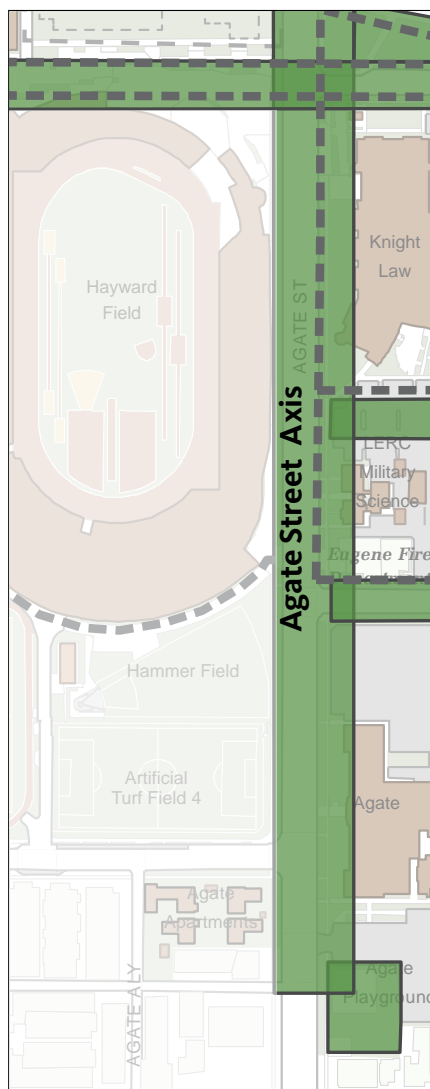

Form

It has a typical street configuration (two lanes of vehicular travel with sidewalks and curbside parking). Much of its form comes from its street trees. Buildings that front the street, such as the Knight Law Center and Agate Hall, partially form the eastern edge of this space. Hayward Field, along with a row of flags and decorative metal fencing, forms the western edge.

Pathways/Gateways

The intersection of this axis with 15th Avenue forms an entrance and gateway to the campus that lies both east and west of the intersection. This gateway is well defined on the west by Powell Plaza and the Hayward Field tower, and on the east by the DeNorval Unthank Jr. Residence Hall building curb extension bump-out. The 15th Avenue Axis, especially the northern sidewalk, is an important pedestrian crossing to the East Campus Area. Also, the 15th Avenue Axis is an important bicycle crossing, since 15th Avenue is a designated university and city bicycle route. The public frequents this area of Agate Street for events at Hayward Field.

The southern end of this axis, at the intersection of Agate Street and 18th Avenue, is the point at which many encounter the university for the first time. As such, it is a primary gateway to those traveling from the south and is shared with bicycles, pedestrians, and private vehicles. Consideration should be given to enhancing this gateway to be a welcoming entrance into campus. The mid-block east-west pedestrian pathway between 15th and 18th Avenues is an important connector between Agate and University Streets.

Trees/Landscape

The eastern edge of the Agate Street Axis has the character of a typical tree-lined street. It is partially lined in a formal arrangement with large-canopy deciduous trees consisting mostly of American sweetgums and Scarlet oaks. The western edge is lined with a combination of street trees including Oaks, Ash, and Ponderosa Pine.

Opportunities and Constraints

Proposals in this area should preserve and strengthen the Agate Street Axis and highlight the importance of the intersection of 15th Avenue and Agate Street. Further enhancement of the axis through buildings and tree canopy is desirable to improve the appearance, to help connect the East Campus Design Area to the center of campus, and to shade the street surface. Refer to the *2003 Development Policy for the East Campus Area* for additional information. An opportunity to mark the beginning of the campus with a gateway element exists at or near the intersection of 18th Avenue and Agate Street.

It is important to maintain the mid-block east-west pedestrian pathway, adjacent to the south side of Hayward Field, from Agate Street to University Street, as it is the only way to pass through this large super block. Encourage solutions to keep it open, particularly when there are no events (E.g work with Athletics).

Opportunity exists to enhance the connection to and view into the Agate to Columbia Axis. This Axis is located mid-block to the east and is an important connection to the East Campus Green. Additionally, establishing a future east-west open space should be explored when the open-space framework is established for the area south of 17th Avenue. (*Refer to the Framework Vision Project (FVP), the 2003 Development Policy for the East Campus Area and the East Campus Open Space Framework Study for more details*).

Opportunities to work with the city to further enhance the bike crossing at the Agate Street and 15th Avenue intersection should be considered. With the improvements of Hayward Field and Powell Plaza, the left turn lane at 15th and Agate was removed, as the only vehicular traffic to the 15th Avenue Axis is service and authorized vehicles. The university and City of Eugene partnered together to install painted crosswalks at this critical intersection, which connects Powell Plaza to the northeast curb extension bump-out on the east side of Agate Street.

Design Area **STUDENT HOUSING**



This area is occupied by large residence halls and a passive recreational open-space area.

Area-wide Space Use Comments

University Housing has primary responsibility for building space use and development planning of the residence halls. After the Phase Three residence hall project (removal of Hamilton Hall and development of the New Green), a new building site north of the New Green will be available for other academic and/or non-housing UO uses. At that time, further refinement to the Design Area description and special conditions should be considered.

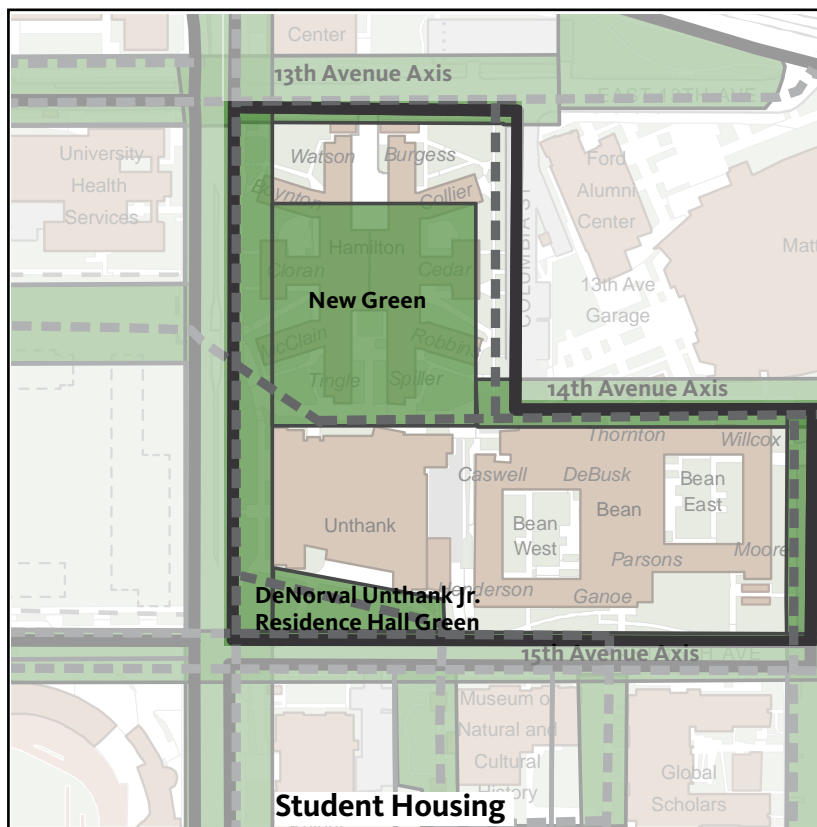

The size of the Design Area is 418,270 square feet. Approximately 36% is Designated Open Space.

13TH AVENUE AXIS: AGATE STREET TO FRANKLIN BOULEVARD

(See description in the Academic Center and Historic Core Design Area for the Kincaid Street to University Street portion of this axis, page 117; and the Northeast Campus--Academics, Research, and Support Services--Design Area for the University Street to Agate Street portion, page 142.)



Current Use

This portion of the 13th Avenue Axis is a city street with a vehicular nature, two-way traffic, curbside parking, and sidewalks. There is also bicycle parking along the sidewalks on both the north and south

sides of the axis near the Jaqua Center. The entrance to the 13th Avenue Parking Garage is located at 13th Avenue and the driveway to Parking Lot 37 (the vacated portion of Columbia Street), adjacent to the Ford Alumni Center, with the garage itself located underneath the building.

Form

It has the character of a typical tree-lined street. Buildings and landscape features lend some form to the axis, including Bakery Park Green and Matthew Knight Arena.

Pathways/Gateways

The intersection of 13th Avenue and Agate Street is a primary auto entrance to the university for westbound traffic on Franklin Boulevard entering 13th Avenue. Because there is no left turn at Agate Street for westbound traffic due to the EmX station, westbound traffic accesses campus at the intersection of 13th Avenue and Franklin Boulevard. At the east side of Agate Street at Franklin Boulevard is a high volume pedestrian crossing. The Millrace Drive Parking Garage located at Millrace Drive and Riverfront Parkway provides increased pedestrian traffic from the part of campus north of Franklin Boulevard at this crossing.

Trees/Landscape

The axis contains some large street trees, is lined with sidewalk planter beds along the Bakery Green, and concrete planters lining the Ford Alumni Center and Matthew Knight Arena front entrances.

Opportunities and Constraints

Proposals for development in this area should preserve and strengthen the 13th Avenue Axis. Further enhancement of the tree canopy is desirable to identify and improve the gateway's appearance, to help connect this portion of the 13th Avenue Axis to the central portion, and to shade the street surface. The University should also look for opportunities to acquire 13th Avenue for better integration into the campus. Any new development in this area (for example, the future building site on the south side of 13th Avenue at Agate Street) should help reinforce the axis. (Refer to the 13th Avenue Axis Conceptual Design Report.) Also, new development needs to consider the unique architecture of the existing buildings and connection to the main campus architectural style.

Further development of Franklin Boulevard through the City of Eugene's Franklin Boulevard Transformation Project will influence this Area. (See *Campus Edge: Franklin Boulevard - Agate St. to Villard St.*, page 164.)

The planned Welcome Center provided by the Phase I Housing Transformation Project will shift the location of the visitor experience.

AGATE STREET AXIS: FRANKLIN BOULEVARD TO 15TH AVENUE

(See description in the Northeast Central Campus--Academics, Student Services, and Housing--Design Area, page 153.)

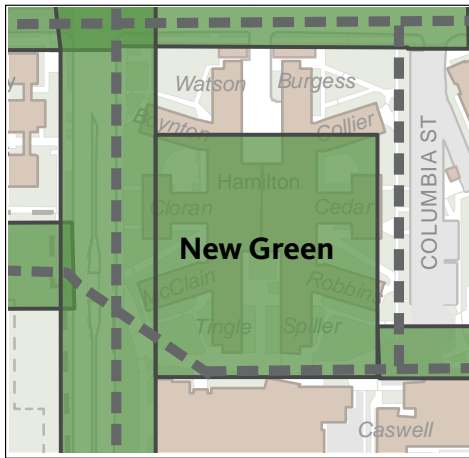

NEW GREEN (NAME TBD)

Current Use

This area was designed to provide informal outdoor activity space for residence hall students. It also is an important pedestrian link between the main campus and East Campus.

Form

The Agate Street edge along the west, the north facade of the DeNorval Unthank Jr. Residence Hall, and the west façade of Bean Hall give this area its form.

Pathways/Gateways

This area includes important pathways that link the main campus via the Promenade to the areas of campus on the east and southeast

Trees/Landscape

This sunny open area is dotted with large and small shade trees.

Opportunities and Constraints

Proposals for development in this area should preserve and strengthen the New Green open space. As development occurs adjacent to the area, it is important to maintain and improve pedestrian access to and through the space. Particular attention should be paid to the mid-block pedestrian crossing between 13th and 15th Avenues. (See the description of this and its relationship to Agate Street in the Northeast Central Campus--Academics, Student Services, and Housing--Design Area, page 147.) As the East Campus Area develops, the pedestrian connections will grow in importance and may result in the need to enhance pathways to the east and southeast. The Agate Street edge could benefit from additional large-canopy trees to help shade the street surface and buffer the New Green from auto traffic. New trees should not interfere with the safety of the area or the intentionally sunny spaces within the green.

As redevelopment occurs at the corner of 13th Avenue and Agate Street, after Hamilton is removed, careful consideration should be given to defining and enhancing the New Green.

14TH AVENUE AXIS: NEW GREEN TO MOSS AXIS

(See description in the Athletics, Student Support, & Administration Design Area for the Moss Axis to Villard Street portion of this axis, page 166.)

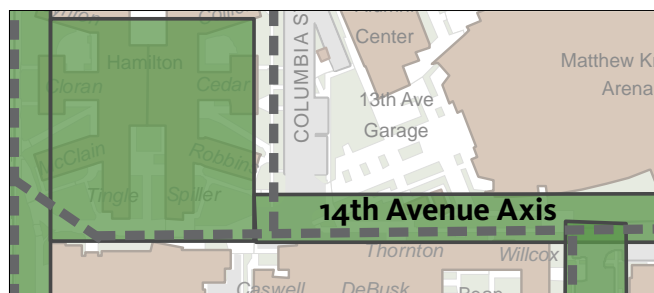

Current Use

This axis has heavy pedestrian use, especially during events at the Matthew Knight Arena and connects the East Campus residence halls to New Green, and across Agate Street Axis to the Promenade. A free-standing structure (built before the designation of this axis) provides elevator access to the underground parking structure. It is also used by service vehicles accessing Bean Hall and Hamilton Hall.

Form

The south edge of this axis is defined by the north facade of Bean Hall. The north edge of the axis is currently not well defined by buildings. The axis consists partly of service access and partly of

informal plantings along the Arena edge. Although many of the neighboring buildings are entered from adjoining greens, the main entrances are clearly visible from the axis.

Pathways/Gateways

The axis is a pedestrian connector in the east/west direction between New Green and Moss Axis. Pedestrian use of this area increased due to the completion of the Matthew Knight Arena, the Ford Alumni Center, and the development of privately-owned student housing complexes to the east of Villard.

Trees/Landscape

This area has some mature trees, but few notable landscape features.

Opportunities/Constraints

Proposals for development in this area should preserve and improve this view corridor, and strengthen the form of the axis, particularly in defining the northern edge. Every effort should be made to improve the connection and view corridor across Agate Street to the Promenade and to the academic core of campus. Also, when possible, take the opportunity to extend this axis eastward to Villard Street. Priority should be given to pedestrians with the understanding that portions of the axis are used by service, delivery, and emergency vehicles. Over time, the design of this axis should diminish vehicular parking and emphasize pedestrians. A system of paving is needed to delineate more clearly the pedestrian path of travel.

15TH AVENUE AXIS: AGATE STREET TO VILLARD STREET

(See description in the Northeast Central Campus--Academics, Student Services, and Housing--Design Area for the University Street to Agate Street portion of this axis, page 152.)

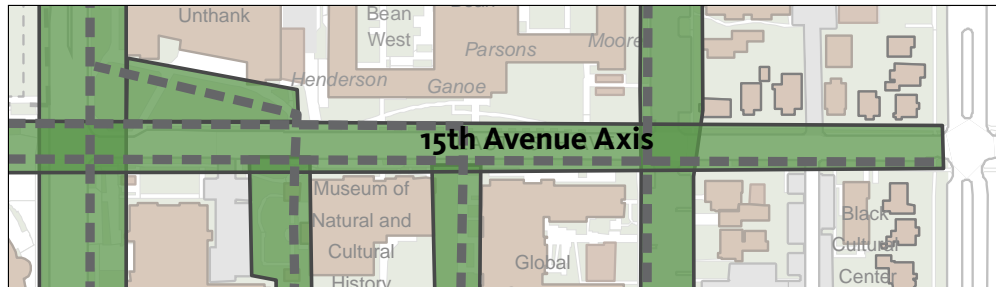

Current Use

This portion of the 15th Avenue Axis is a city street with two-way traffic, curbside parking, and sidewalks.

Form

It has the character of a typical tree-lined

street and is partially defined by the Global Scholars Hall and the Museum of Natural and Cultural History along the south edge.

Pathways/Gateways

This axis is an important link from the East Campus to the main campus. It intersects with a series of north/south pathways and open spaces including the Agate Street Axis, East Campus Axis, Moss Street Axis, New Green, Phase One Residence Hall Building Green and the pathways through the New Green and the Glenn Starlin Green.

Trees/Landscape

Large canopy deciduous trees line the north and south edges of the axis, particularly on the western portion of this axis. Efforts to shade the street surface, by planting new large-canopy trees to complete the allée are a priority.

Opportunities and Constraints

Proposals in this area should preserve and strengthen the axis, which provides an important connection to the main campus and merits enhancement. Special attention should be given to

preserving and enhancing connections with and views into intersecting pathways and axes. Future opportunities exist to create a campus gateway at Villard Street as a transition to surrounding neighborhood development.

Connections to future open spaces should be explored when the open-space framework is established for the area east of Moss Street. For more details refer to the 2003 *Development Policy for the East Campus Area* and the *East Campus Open Space Framework Study*.

DENORVAL UNTHANK JR. RESIDENCE HALL GREEN

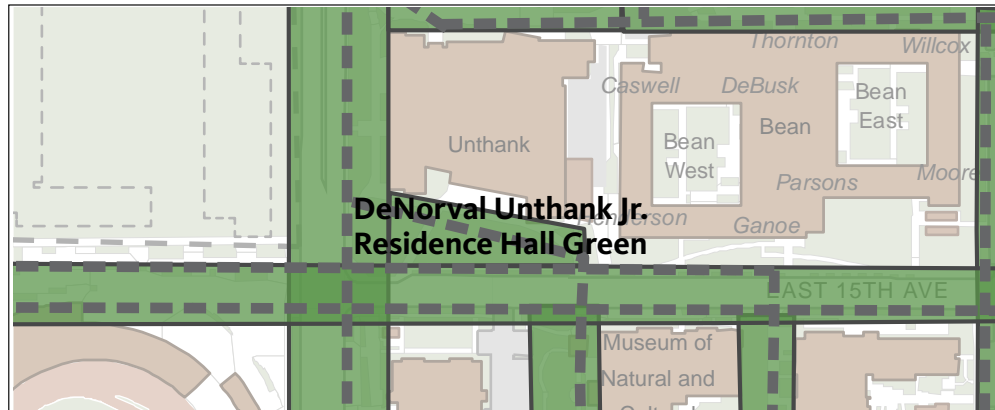

Current Use

This green provides south-facing open space which accommodates exterior functions associated with the dining hall in the DeNorval Unthank Jr. Residence Hall. It also provides a significant, primary pedestrian connection between the core of campus and areas further to the east and

southeast. Providing sufficient space to accommodate a gracious campus connector in this location is of particular significance because it provides the only major north-south pedestrian pathway on this block. This connection will become even more significant as East Campus develops further. For this reason, it is important to preserve the open space and protect it from development in the future.

Form

This green is a mix of landscape and hardscape (associated with the dining terrace). It is defined by building edges on the north and by the 15th Avenue edge on the south.

Pathways/Gateways

A heavily-used pedestrian pathway through this green connects the campus core to areas further to the south and east. This is a primary pedestrian pathway and provides a sense of campus continuity with the academic core.

Trees/Landscape

A collection of established trees, including a pair of mature Northern Red Oaks on the south of the open space are character-defining features of this open space as well as of this portion of the 15th Avenue Axis.

Opportunities and Constraints

Proposals in this area should preserve and strengthen the open space and pathways, which provide an important connection between the core of campus and areas of campus further to the east and south. If the opportunity arises in the future, consider expanding this open space further to the south (into 15th Avenue Axis) to enhance the primary pedestrian connection even further.

Design Area

ATHLETICS, STUDENT SUPPORT, AND ADMINISTRATION

This design area includes a mix of athletic uses, student support services, administrative offices, transportation facilities, meeting spaces, and related active and passive open spaces. The two Designated Open Spaces within the design area boundary are Bakery Park Green, and the 14th Avenue Axis: Moss Axis to Villard Street.

Area-wide Space Use Comments

This area is occupied by a large-scale athletic and regional events facility, as well as student support and administration facilities. This is an important campus main gateway, where prospective students and visitors arrive

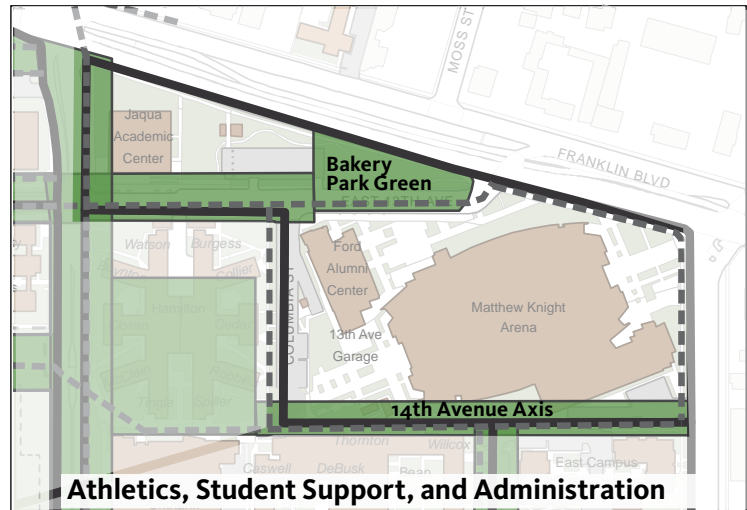

The size of the Design Area is 514,000 square feet. Approximately 28% is Designated Open Space.

for tours. Improvements to this area should take advantage of the unique opportunities to enhance way-finding experiences of newcomers to the University. Combined with the Northeast Campus Design Area and the Northeast Central Design Area, this area provides an opportunity for the development of a major gateway to the campus. Plans for improvements should respond to these opportunities.

In addition, the land where the Matthew Knight Arena is located is governed by a City of Eugene conditional use permit and improvements to this area need to comply with those requirements. Specifically, this will affect requirements for landscaping, bike parking and other site features.

Campus Edge: Franklin Boulevard - Agate St. to Villard St.

(Also refer to the Franklin Boulevard Axis description in the Northeast Campus - Academics, Research, & Support Services - Design Area, page 141.)

The developed Franklin Boulevard streetscape located along the sidewalk in this area currently provides a landscape buffer from heavy vehicle traffic. Mature evergreen and deciduous trees provide shade and human scale for pedestrians. The landscape buffer along the north side of Matthew Knight Arena, along with the wider sidewalk, accommodates larger groups of pedestrians during events. A main gateway entrance to campus is located at the corner of Franklin Boulevard and 13th



Avenue. Further development of the gateway should convey the look and feel of campus to a larger audience, including some whom may never set foot on the campus but pass it daily. This location also sets the visual boundary of campus from the east, and, notably sets a tone for the interface between the campus and its neighbors. Additional consideration should include enhancing this

gateway to be a welcoming entrance into the campus.

Further development of Franklin Boulevard through the City of Eugene's future Franklin Boulevard redesign project will create opportunities to enhance the intersections of Franklin Boulevard with Agate, Moss, and Villard Streets. The purpose of this project is to transform Franklin from an auto-focused former state highway (under city jurisdiction today) to a pleasant, multi-modal urban street designed for slower vehicle speeds that is safer for people walking, biking, riding the bus and driving. Instead of being a divider between UO and the surrounding community, the boulevard will transform into a more comfortable connector of places. Opportunities for safe pedestrian crossings, through roundabouts, reduced crossing distances, and new crossing refuges will improve this area of Franklin Boulevard. As part of the transformation project, the City is planning to add an intersection at Moss Street on Franklin Boulevard that will require a reconfiguration of the University's land as well as 13th Avenue.

This area is highly visible to the public. Every opportunity should be taken to improve its visual qualities and convey the university's public role, mission, and history. *(For a description of Franklin Blvd. west of Agate Street, also refer to the Northeast Campus - Academics, Research, and Support Services - Design Area Campus Edge description, page 145.)*

AGATE STREET AXIS: FRANKLIN BOULEVARD TO 15TH AVENUE

(See description in the Northeast Central--Academics, Student Services, and Housing--Design Area, page 153.)

BAKERY PARK GREEN

Current Use

This green at the eastern end of this design area is passive open space.

Form

The green is formed by streets on two sides and a parking lot on the other.

Pathways/Gateways

13th Avenue has become the major automobile entrance to the campus from the east, and is public right of way under City of Eugene jurisdiction. There is a meandering pedestrian path that stretches through the park from east to west. A portion of this path is bordered by a campus parking lot and also 13th Avenue.

Trees/Landscape

This area has some groupings of trees and young deciduous street trees. There is an open lawn space at the corner of 13th Avenue and Franklin Boulevard. A landscape strip of plantings is located between the sidewalk and Franklin Boulevard.

Opportunities and Constraints

Westbound traffic on Franklin Boulevard turn left onto 13th Avenue and pass the green. *(Refer to the 13th Avenue Axis Conceptual Design Report.)* This is an opportunity to develop a main gateway with signage or other landscape features announcing their arrival at the campus. This is a gateway that is shared with private vehicles, buses, and bicyclists and should be enhanced as a welcoming entrance to campus. This is also the predominant southbound route in the area for traffic.

Further development of Franklin Boulevard through the City of Eugene's Franklin Boulevard Transformation Project will influence this area. *(See Campus Edge: Franklin Boulevard - Agate St. to Villard St., page 164.)*



14TH AVENUE AXIS: MOSS AXIS TO VILLARD STREET

(See description in the Student Housing Design Area for the New Green Agate Axis portion of this axis, page 161.)

Current Use

This portion of the 14th Avenue Axis is a pedestrian pathway. The eastern portion is not well defined, and the physical pathway ends after Bean Hall, where there is a parking lot, and then continues again along the east building of the Graduate Village.



Form

The current form of this axis is partially defined by Bean Hall. The eastern portion is not well defined.

Trees/Landscape

This area has some mature trees in the parking lot portion of the axis, and a row of landscape shrubs and groundcover bordering its edges. Otherwise there are few notable landscape features.

Pathways/Gateways

The axis is a pedestrian pathway that connects to the Student Housing Design Area and Northeast Central Campus Design Area.

Opportunities and Constraints

Special attention should be given to creating a strong pedestrian connector to and along the south side of the Matthew Knight Arena pedestrian pathway to Villard Street. This should result in a direct pedestrian route, enhanced with lighting, planting, and wayfinding. This route, while currently used, is uninviting as it borders the backs of buildings and flows through parking lots, such as the East Campus Graduate Village Parking lot.

Design Area EAST CAMPUS

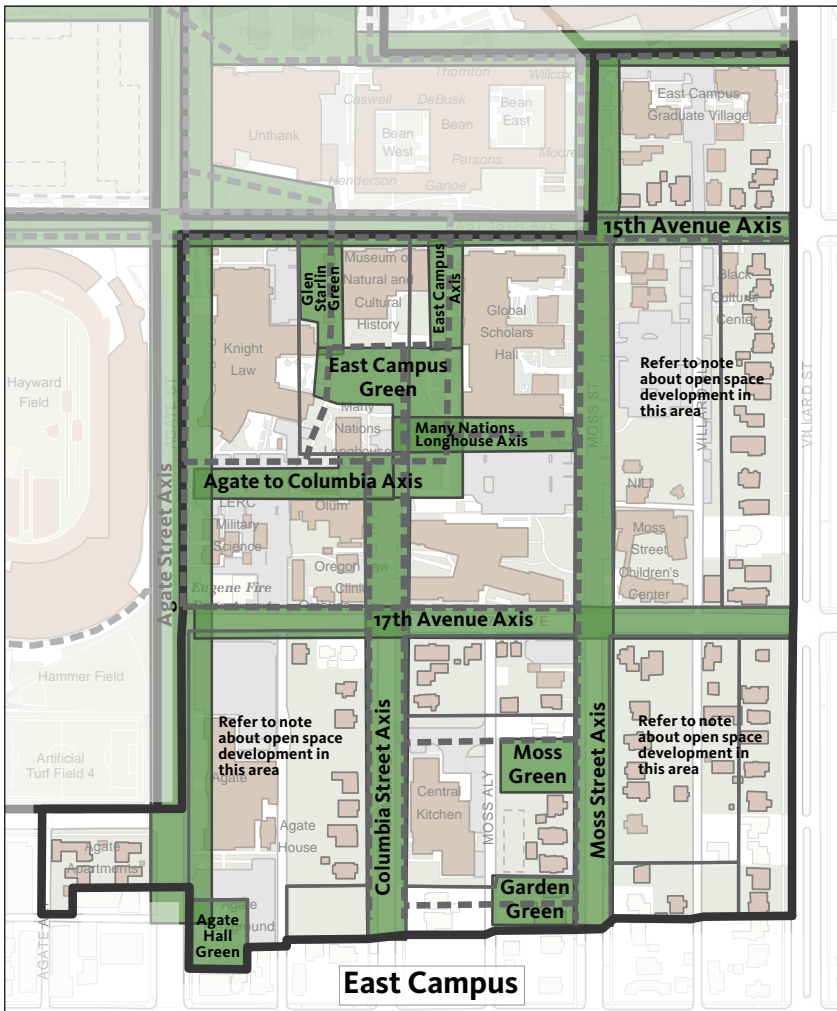

13TH AVENUE AXIS: AGATE STREET TO MOSS STREET
 (See description in the Student Housing Design Area, page 160.)

Area-wide Space Use Comments
 This area includes a mix of institutional structures and low-density student-housing units. It is within the boundaries established in the 2003 *Development Policy for the East Campus Area* and the *Fairmount/VO Special Area Study* (1981, as amended). Development shall follow the principles and standards adopted in the development principle and the special-area refinement plan.

Designated Open Spaces in the East Campus Area are described below (with the exception of the Agate Hall Green). Requirements described in the 2003 *Development Policy for the East Campus Area* and the *East Campus Open Space Framework Study* are designed to expand the open-space framework throughout East Campus.

The approximate size of the Design Area is 1,185,625 square feet (including City-owned streets). Approximately 27% is Designated Open Space.

The area south of Agate Hall is included in the *19th and Agate Special Area Study* (1988). Proposals for the area's redevelopment are to consider applicable principles articulated in that study and conform to development standards imposed by the City of Eugene.



Campus Edge: Villard Street
 Refer to 2003 *Development Policy for the East Campus Area*.

NOTE: The open-space framework in the outer portions of the East Campus are largely undeveloped. Refer to the *Development Policy for the East Campus Area* and the *East Campus Open Space Framework Study* (2004) for additional information. Refer to the *University Street Feasibility Study* (2012) for additional information about the potential expansion of the open-space framework in the Esslinger Hall and Mac Court area.

EAST CAMPUS GREEN

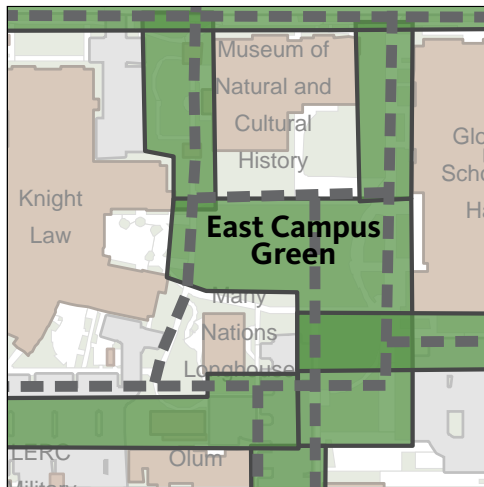

Current Use

This open space is used for both passive and active outdoor recreation and events by occupants of neighboring buildings. Its path system makes significant pedestrian connections to main campus. The eastern edge of the green serves as a fire lane for the Global Scholars Hall.

Form

This green is a mix of hardscape and landscape with a change in topography rising to the east. It is partially defined by building edges.

Pathways/Gateways

A path system connects north/south and east/west. It is bisected by the Many Nations Longhouse Axis. Secondary building entrances face out onto the green.

Trees/Landscape

The open space contains a large open grassy area with a mix of evergreen and deciduous trees primarily along the north and south edges. The David Brower Sequoia is a good example of its species. An area of native grasses creates a bioswale east of the Many Nations Longhouse. While located outside the open-space boundaries, the Many Nations Longhouse green roof and surrounding natural vegetation also contribute to the open space.

Opportunities and Constraints

Preserve and enhance this green as the heart of East Campus and the path system that serves significant pedestrian connections to main campus and the rest of East Campus. Future development, such as the eventual southward expansion of the Museum of Natural and Cultural History and the eastward expansion of the Many Nations Longhouse should further define the edges and enliven the green. Refer to the Memorandum of Understanding for the Museum of Natural and Cultural History Phase 3 Expansion and East Campus Residence Hall (known as Global Scholars Hall) Project (November 9, 2009).

Relocation of the parking elements within this open space is essential to the formation of a pedestrian-oriented open space. Because the Many Nations Longhouse has a special relationship with Oregon's Nine Federally Recognized Tribes and the elders of those nations, and because the Longhouse has special ceremonial functions, parking/drop off needs of the Many Nations Longhouse will be considered and addressed at all stages of the future development of the East campus region. However, the goal should be to do so while giving priority to pedestrians. The details of meeting the parking drop/off needs will be implemented in accordance with the Memorandum of Understanding between the University of Oregon and Oregon's Nine Federally Recognized Tribes at the time of the dedication of the Many Nations Longhouse in January 2005. (Memorandum is on file in the Longhouse, the President's Office, and the University Archives.)

Preserve and enhance passive and active outdoor recreation within the green or adjacent to it. Provide open sunny spaces to allow for active recreation. Pay attention to the unique attributes of adjacent landscapes and uses (i.e., Many Nations Longhouse and Museum of Natural and Cultural History). An outdoor Many Nations Longhouse "Expression Place" will be established east of the longhouse in alignment with the Many Nations Longhouse Axis (refer to the Many Nations Longhouse Axis, page 170).

EAST CAMPUS AXIS

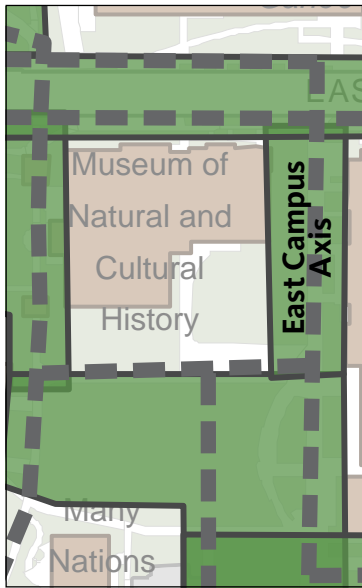

Current Use

Intended as a primary pedestrian access route to East Campus from the main campus and a view corridor to the East Campus Green, this axis also serves as access to the Museum of Natural and Cultural History's service zone and as a fire lane for the Global Scholars Hall.

Form

Buildings define the edges.

Pathways/Gateways

A north/south pedestrian pathway serves as a primary entrance to the East Campus Green with a gateway demarcating access to the green at the 15th Avenue intersection. Secondary building entrances face out onto the axis.

Trees/Landscape

A line of Douglas-firs with other deciduous trees line the path.

Opportunities and Constraints

Preserve and enhance the axis as a primary pedestrian access into the East Campus Green from 15th Avenue. It is recognized that the axis must still meet limited service needs for the Museum of Natural and Cultural History and serve as a fire lane; however, the goal should be to do so while giving priority to pedestrians. Refer to the Memorandum of Understanding for the Museum of Natural and Cultural History Phase 3 Expansion and East Campus Residence Hall (known as Global Scholars Hall) Project (November 9, 2009).

An opportunity exists to enhance the view corridor from 15th Avenue. As redevelopment occurs on the Bean Hall site, consider extending the pedestrian access across 15th Avenue to create a stronger connection to main campus.

AGATE TO COLUMBIA AXIS

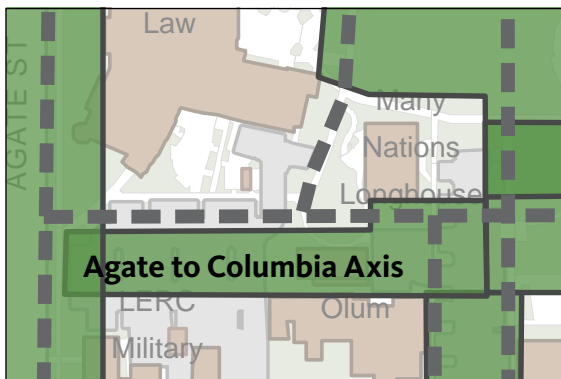

Current Use

This axis is used by pedestrians and is a view corridor to the East Campus Green. Portions of the axis currently serve as parking and provide service vehicle access.

Form

It is defined by building edges, but currently functions as a parking lot.

Pathways/Gateways

The east/west pathway connects the Agate Street Axis, the East Campus Green, and the Columbia Street Axis.

Trees/Landscape

The unique native landscaping associated with the Many Nations Longhouse helps define the northern edge of the axis.

Opportunities and Constraints

Relocation of the non-service parking elements and the temporary Vivian Olum Child Development Center modular within this axis is essential to the formation of a green pedestrian access. It is recognized that service needs for adjacent buildings and special drop off/parking needs for the Olum Child Development Center and the Many Nations Longhouse still must be met. Because the Many Nations Longhouse has a special relationship with Oregon's Nine Federally Recognized Tribes and the elders of those nations, and because the Longhouse has special ceremonial functions, parking/drop off needs of the Many Nations Longhouse will be considered and addressed at all stages of the future development of the East campus region. However, the goal should be to do so while giving priority to pedestrians. Future development should further define the edges and enhance pedestrian routes and views. Pay attention to the unique attributes of adjacent landscapes and outdoor uses (i.e., Many Nations Longhouse and the Olum Child Development Center). Recognize that plans for a southern expansion of the Knight Law Center do not yet have exact dimensions defined and may result in a request to adjust the open space boundary to the south of the law center. Such an amendment would be favorably considered if it meets the intent of the open space.

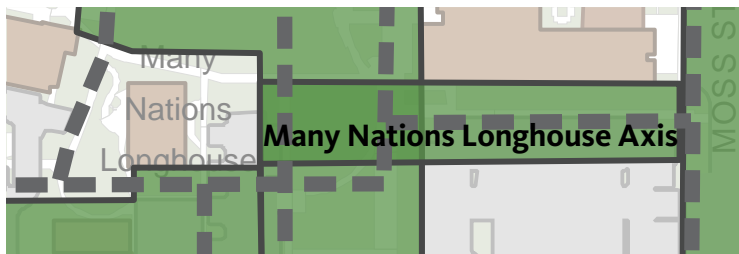

MANY NATIONS LONGHOUSE AXIS

Current Use

This axis is used by pedestrians and is an eastern view corridor from the planned Many Nations Longhouse “Expression Place.” Portions of the axis currently serve as parking.

Form

The northern side is landscaped and defined by the Global Scholars Hall.

Pathways/Gateways

The east/west pathway connects the Agate to Columbia Axis and the East Campus Green.

Trees/Landscape

Landscaping delineates the axis and acts as a buffer for first-floor residents.

Opportunities and Constraints

Relocation of the parking elements within this axis is essential to the formation of a green pedestrian access. Future development should further define the edges, enhance pedestrian routes, and consider solar access.

Pay attention to the unique attributes of landscapes and uses associated with the Many Nations Longhouse. An outdoor Many Nations Longhouse “Expression Place” will be established in alignment with the Axis. Preserve eastern views from the planned “Expression Place.” Accommodate places for art in the view corridor.

There is potential to connect to future development and pathway systems east of Moss. For more details refer to the 2003 *Development Policy for the East Campus Area* and the *East Campus Open Space Framework Study*.

GLENN STARLIN GREEN (also known as the Glenn Starlin Courtyard)

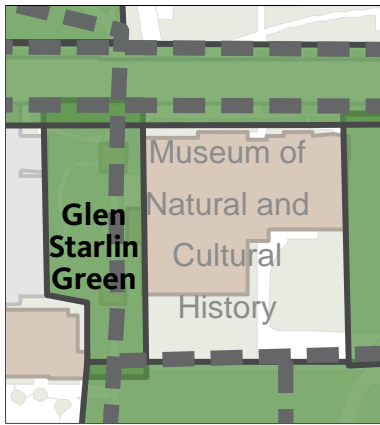

Current Use

This quiet green serves only pedestrians as a primary entrance to East Campus from the main campus. It also is an outdoor classroom associated with the Museum of Natural and Cultural History.

Form

The Museum of Natural and Cultural History and clusters of native plantings and trees form the edges of the green. Large timber gateways mark the north and south entrances.

Pathways/Gateways

A north/south pedestrian pathway runs along the eastern edge serving as a primary entrance to the East Campus Green from the

15th Avenue Axis and the Humpy Lumpy Green pathway. It also leads to the entrance of the Museum of Natural and Cultural History. A pathway circles the green with sunny seating areas and a display of native plants.

Trees/Landscape

A variety of evergreen and deciduous trees and native plants creates an outdoor classroom.

Opportunities and Constraints

The Glenn Starlin Green can be enhanced to serve additional outdoor activities associated with the museum, preserve native plantings, and buffer adjacent service and parking areas. Every effort should be made to create a stronger public connection and enhance views from the Humpy Lumpy Green and 15th Avenue into the East Campus Green. Enhance the visual connection from the intersection at Agate Street and 15th Avenue to the museum.

COLUMBIA STREET AXIS: EAST CAMPUS GREEN TO 19TH AVENUE



(Note: Further work is required to describe the special conditions of this axis south of 17th Avenue. Connections to other open spaces should be explored when the open-space framework is expanded in this area. For more details refer to the 2003 Development Policy for the East Campus Area and the East Campus Open Space Framework Study.)

Current Use

This axis is used moderately by pedestrians, bicyclists, and vehicles (access and parking) and is owned by the university. It serves as the principle pedestrian access to the East Campus Green from the south.

Form

It has a typical street configuration (two lanes of auto travel with sidewalks). Trees in the green parking strips help define the form.

Pathways/Gateways

North/south pedestrian pathways exist along the street edge. The axis intersects with the 17th Avenue Axis and the Agate to Columbia Axis and the Many Nations Longhouse Axis.

Trees/Landscape

There is a nice collection of newly-planted deciduous trees along the Kalapuya Ilihi facade.

Opportunities and Constraints

Make an effort to integrate design features that enhance pedestrian and bike access along the entire street. Work with the city to ensure special attention is given to the 17th Avenue pedestrian intersection crossing and a mid-block crossing between 17th and 19th Avenues. Opportunities exist to reduce traffic and speed to enhance pedestrian access and safety, particularly for children of the Vivian Olum Child Development Center as well as the children, elderly, and disabled who come to the Many Nations Longhouse. It is also important to recognize that the Many Nations Longhouse is located at the end of Columbia Avenue and should not become landlocked. Therefore, it is recognized that service needs for adjacent buildings and special drop off/parking needs for the Olum Child Development Center and the Many Nations Longhouse still must be met. It is desirable to define the form and edges through buildings and trees. Generally, primary building entrances should face the street. Use trees to shade the street surface. Consider small pockets of head-in parking as a way to add variety to the street and calm traffic.

MOSS STREET AXIS: 15TH AVENUE TO 19TH AVENUE

(Note: Further work is required to describe the special conditions of this axis north of 15th Avenue and south of 17th Avenue. In addition, connections to other open spaces should be explored when the open-space framework is expanded in these areas. For more details refer to the 2003 Development Policy for the East Campus Area and the East Campus Open Space Framework Study.)

Current Use

This axis, used moderately by pedestrians, bicyclists, and vehicles, is owned by the city.

Form

This axis has a typical street configuration (two lanes of auto travel with sidewalks), and some of the surrounding buildings have entrances facing this axis. Trees occupy the green parking strips. Speed bumps and narrowing of the road at the intersections help slow traffic.

Pathways/Gateways

North/south pathways extend along the street edge and intersect the 15th Avenue Axis, a major pedestrian and bike connection to campus. The axis intersects the Many Nations Longhouse Axis and the 17th Avenue Axis.

Trees/Landscape

Broad green strips of grass with large canopy trees provide shade and a buffer between sidewalks and parking.

Opportunities and Constraints

Make an effort to integrate design features that enhance pedestrian and bike access along the entire street. Work with the city to ensure special attention is given to the 17th Avenue pedestrian intersection crossing and a mid-block crossing between 17th and 19th Avenues. Opportunities exist to reduce traffic and vehicle speed. Local traffic and parking, Matthew Knight Arena special-event traffic, and service vehicles could use the street, but priority would be given to pedestrian and bike movement. Pay particular attention to creating a safe environment for children of the Moss Street Children's Center. It is desirable to better define the form and edges through buildings and trees.

Note: The open-space framework in the outer portions of the East Campus Area are largely undeveloped. Refer to the *Development Policy for the East Campus Area* and the *East Campus Open Space Framework Study (2004)* for additional information. Refer to the *University Street Feasibility Study (2012)* for additional information about the potential expansion of the open-space framework in the Esslinger Hall and Mac Court area.

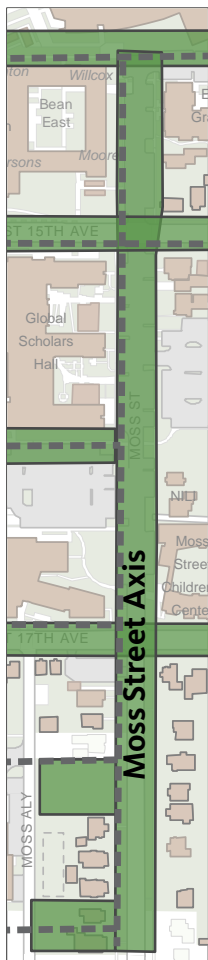

Use trees to shade the street surface. Future development should treat this axis as a transition area between larger-scale and smaller-scale development. Consider small pockets of head-in parking as a way to add variety to the street and calm traffic.

17TH AVENUE AXIS: AGATE STREET TO MOSS STREET

(Note: Further work is required to describe the special conditions of this axis east of Moss Street. In addition, connections to other open spaces should be explored when the open-space framework is expanded in this area. For more details refer to the 2003 Development Policy for the East Campus Area and the East Campus Open Space Framework Study.)

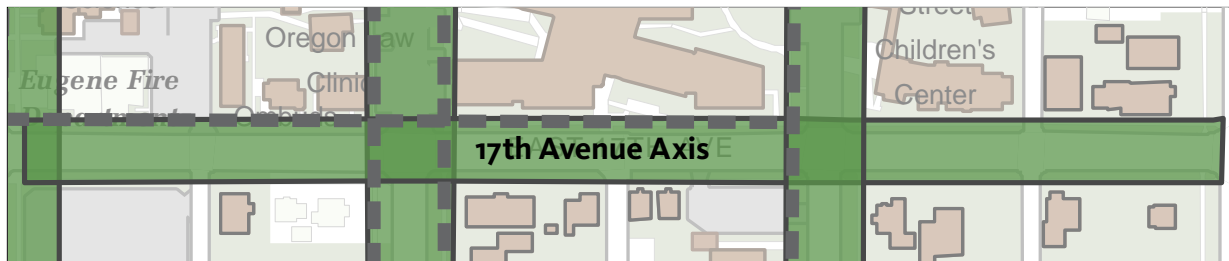

Current Use

This city-owned street is used moderately by pedestrians, bicyclists, and vehicles.

Form

It has a typical street configuration (two lanes of auto travel with sidewalks). A row of mature street trees occupies the green parking strips.

Pathways/Gateways

This axis's east/west pedestrian pathways intersect with Moss Street Axis, Columbia Street Axis, and Agate Street Axis.

Trees/Landscape

The 17th Avenue Axis has the character of a typical tree-lined street. The large deciduous trees consist mainly of American elms and London plane trees.

Opportunities and Constraints

Development in this area should preserve and enhance connections to the East Campus Green and to the main campus. Building edges and front doors facing 17th Avenue can strengthen the form. Additional trees can shade the street surface and further define the form. Opportunities to work with the city to enhance the pedestrian and bike crossing at the Agate Street intersection should be considered. Similar opportunities exist at the Moss Street and Columbia Street intersections. The opportunity exists to encourage the use of 17th Avenue for automobile entrances and exits to and from the area.

AGATE STREET AXIS: 15TH AVENUE TO 18TH AVENUE

(See description in the Southeast Campus--Academics, Athletics, and Recreation--Design Area, page 157.)



MOSS GREEN

(Note: Further work is required to describe the special conditions of open spaces east of Moss Street that would connect to this open space. For more details refer to the 2003 Development Policy for the East Campus Area and the East Campus Open Space Framework.)

Current Use

This quiet green has been informally used as a garden by the adjacent

property owners.

Form

Currently, the green is an informal residential garden and a vacant lot.

Pathways/Gateways

A pedestrian and bike pathway is designed to pass through the green and connect Moss Street to Columbia Street serving as a secondary east/west route. Priority should be given to pedestrians and bicyclists, but the path should be wide enough to safely accommodate small delivery carts. The intent is to provide an alternative bike and pedestrian route and to bring activity to the green space. The exact location and shape are not as important as the intent to create an east/west route.

Trees/Landscape

A mix of evergreen and deciduous trees is on the site. Special care should be given to the mature Incense Cedar.

Opportunities and Constraints

It is assumed that the existing use can remain intact until the existing adjacent occupants are not using the site as a garden space. At that time the goal would be to transform the green into a pedestrian-only, small-scale open space for use by adjacent building occupants.

In addition, the green should feature an east/west route that extends through the block. Every effort should be made to create a clear public connection and provide views from Moss Street to Columbia Street. Priority should be given to pedestrians and bicyclists, but the pathway should be wide enough to safely accommodate small delivery carts. Also, special care should be given to ensure a safe alley crossing.

Future development should help define the park edges and enliven it. However, primary building entrances should face the street. Consideration should be given to retaining existing garden plantings as appropriate (further assessment is required). Also, plantings should be used to buffer adjacent service and parking areas, such as small alley parking lots).

GARDEN GREEN

(Note: The overall intent is to extend the Garden Green along the East Campus Area's southern boundary. Some lots in this area are already used as garden space (e.g., Columbia Garden) while others are privately owned (e.g., the lots west of the Garden Green facing Columbia Street). Expansion of the Garden Green would occur over time and only affect UO-owned properties. Further work is required to describe the special conditions of these future open spaces that would become part of the Garden Green. For more details refer to the 2003 Development Policy for the East Campus Area and the East Campus Open Space Framework.)

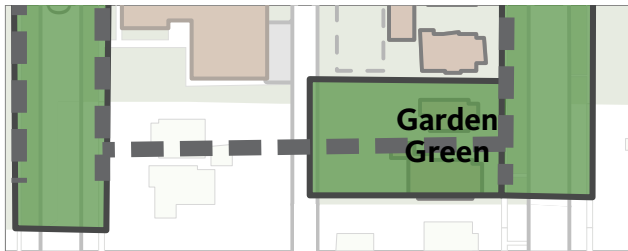

Current Use

Currently the Green is used as single-family residential housing.

Form

Currently the Green is comprised of multiple single-family residential dwelling units.

Pathways/Gateways

A pedestrian pathway is designed to pass through the green and connect Moss Street to Columbia Street serving as a secondary east/west route that bisects the block.

Trees/Landscape

A mix of evergreen and deciduous trees is on the site. Pay special attention to the Giant Sequoia.

Opportunities and Constraints

Future efforts should focus on transforming the Green into a pedestrian-only garden space with an emphasis on residential-scale food production (e.g., urban garden, orchard, etc.). It should incorporate an east/west pedestrian route taking special care to plan for a safe alley crossing and the future connection to a pathway that leads to Columbia Street. This transition into a green space would require the removal of existing single-family residences. All single-family residences proposed for removal should be treated in a manner described in the *2003 Development Policy for the East Campus Area*. All future uses and design features should ensure that this Green serves as a graceful transition between university uses and private residential uses. Plantings should be used to buffer garden-related service and parking areas, particularly from adjacent private residential uses. Future development should help define the Green's edges and enliven it. However, primary building entrances should face the street.

AGATE HALL GREEN

(Note: Further work is required to describe the special conditions of this Green. For more details refer to the 2003 Development Policy for the East Campus Area and the East Campus Open Space Framework Study.)

APPENDICES



Appendix A: University of Oregon Mission

University of Oregon Mission Statement

Serving the state, nation and world since 1876 The University of Oregon is a comprehensive public research university committed to exceptional teaching, discovery, and service. We work at a human scale to generate big ideas. As a community of scholars, we help individuals question critically, think logically, reason effectively, communicate clearly, act creatively, and live ethically.

Purpose

We strive for excellence in teaching, research, artistic expression, and the generation, dissemination, preservation, and application of knowledge. We are devoted to educating the whole person, and to fostering the next generation of transformational leaders and informed participants in the global community. Through these pursuits, we enhance the social, cultural, physical, and economic wellbeing of our students, Oregon, the nation, and the world.

Vision

We aspire to be a preeminent and innovative public research university encompassing the humanities and arts, the natural and social sciences, and the professions. We seek to enrich the human condition through collaboration, teaching, mentoring, scholarship, experiential learning, creative inquiry, scientific discovery, outreach, and public service.

Values

- We value the passions, aspirations, individuality, and success of the students, faculty, and staff who work and learn here.
- We value academic freedom, creative expression, and intellectual discourse.
- We value our diversity and seek to foster equity and inclusion in a welcoming, safe, and respectful community.
- We value the unique geography, history and culture of Oregon that shapes our identity and spirit.
- We value our shared charge to steward resources sustainably and responsibly.

Appendix B: Oregon Experiment Principles

The University of Oregon's *Campus Plan* reaffirms the six basic principles articulated in *The Oregon Experiment* as the underlying premises of this Plan.

ORGANIC ORDER: The campus emerges through a process, not from a map.

ORGANIC ORDER emerges gradually from separate actions guided by shared values and processes. This melding of individual actions into a cohesive whole comes not from a predetermined fixed-image map, but from the application of a process guided by explicitly debated and approved basic principles or “patterns,” which articulate the shared traditions and understandings of the university community.

INCREMENTAL GROWTH: Development occurs in large and small pieces.

The precept of INCREMENTAL GROWTH (originally known as piecemeal growth) acknowledges that the development of the campus occurs gradually as the result of individual acts of new construction, repair, rehabilitation, and remodeling taking place over time. The principle suggests that the campus needs both large and small projects and needs both new construction and repair that allow for continuous care and improvement in order to create a complete and healthy campus environment.

PATTERNS: Shared design statements guide the planning process.

PATTERNS establish a means of articulating commonly held values about the campus environment. Patterns are design statements that describe and analyze project-related issues and suggest ways in which those issues might be resolved. Patterns that are to be considered and addressed at various levels are identified in appropriate places in this Plan.

DIAGNOSIS: Assessing existing conditions informs ongoing improvements.

DIAGNOSIS establishes a process of periodic analysis or diagnosis of the present state of the campus to guide its repair and improvement. The principle of diagnosis is embodied in the provisions of this document related to Area and Site Diagnosis Studies and Academic Planning Coordination (which includes the *Biennial Capacity Plan*).

PARTICIPATION: User involvement must prevail throughout the planning process.

The principle of PARTICIPATION is reaffirmed as the cornerstone of the university's planning process and is viewed as an extension of a long-established history of shared governance at the university. It occurs on each project (as defined by this Plan) principally through a user group appointed by the chair of the Campus Planning Committee. This principle also is embodied in the review processes articulated in this Plan.

COORDINATION: Working together benefits the campus as a whole.

COORDINATION recognizes that the university as a whole has interests that must be represented, and that coordination of separate development activities is essential if they are to result in a cohesive campus. The Campus Planning Committee is charged with the responsibility for providing this function and is authorized to establish rules and procedures for discharging this responsibility.

Appendix C: Assumptions

The *Campus Plan* is based on a number of assumptions:

1. The fundamental precepts of the university's mission will remain unchanged, and the University of Oregon will continue to exist as a quality institution of higher education.
2. Buildings and the spaces within them belong to the State of Oregon and are allocated for use by the university to various programs and activities within the university, in accord with the requirements of relevant Oregon Administrative Rules and Statutes. The physical plant of the university is intended to support the institution's mission, and it should be responsive to its programmatic needs.
3. Existing organizational and working relationships among the university, other state agencies, and local governments, will continue essentially unchanged.
4. Specific programs, enrollment levels, and environmental circumstances of the University of Oregon will change over time in ways and amounts that cannot be determined in advance within a meaningful degree of accuracy.
5. The University of Oregon will continue to be a part of the Eugene-Springfield urban community. Except as may be needed to accommodate a few specialized programs or activities, no major land acquisition will occur outside the presently approved campus boundaries.
6. The *Campus Plan* will meet applicable Oregon State Board of Higher Education's Administrative Rules and Internal Management Directives. (Refer to Appendix E.)

Appendix D: Future "To Do" Items

In discussions about updating the *Campus Plan*, the items listed below were identified as appropriate subjects for consideration in the continuing discussions on university campus development principle. They are listed in no particular order.

1. Revise the *UO Long Range Campus Transportation Plan*.
2. Review ways to improve the link between the academic planning process and the physical development planning process. Develop strategies to review existing uses and establish a plan to maximize existing space based upon the Space Use and Organization principle refinements.
3. Build upon recent efforts (*Heritage Landscape Plan*) to develop more detailed analysis of the existing and desired campus character, in particular of open spaces. Determine how to extend these characteristics to newer areas of campus to create a cohesive campus environment. Pay attention to campus edges and town/gown interactions.
4. Better define development plans and principles for UO development outside the Approved Campus Boundaries as appropriate.

Appendix E: Oregon State Requirements

In 2011 SB 242 was adopted (it became operative January 1, 2012). It redefined the Oregon University System as the public university system with more authority and independence to manage affairs, operations, and obligations. It exempts Oregon University System from certain laws relating to state agencies. It allows universities to be established as Independent Institutions of Higher Education.

In 2014 the University of Oregon became a public university governed by an independent board. A public university governed by an independent board has greater autonomy from the Oregon University System. Also, it is not considered a unit of local or municipal government or a state agency, board, commission or institution for purposes of state statutes or constitutional provisions.

This document is intended to comply with these requirements in a way that honors the established campus planning process.

Appendix F: Planning Process to Update the Plan in 2005

The goal of the Campus Plan Update project was to update the 1991 *Long Range Campus Development Plan (LRCDP)*, while maintaining its fundamental concepts, so that it would effectively guide the next ten years of campus development.

The *LRCDP* was almost fifteen years old at the beginning of the update process. It had guided the university through an active period of development and improvements resulting in a noticeably enhanced campus environment. Although the fundamental concepts of the *LRCDP* remained effective, portions of the 1991 document needed to be evaluated for potential improvements, and outdated information needed to be revised.

The university's emphasis on user participation was evident throughout the update process and remains a key part of the updated *Campus Plan*. Opportunities for input began in the summer of 2004 with meetings among key campus and community members, who defined the scope of the update and the participatory process. A core Advisory Group representing faculty, staff, and students, the Campus Planning Committee, Facilities Services, and others served as a review body throughout development of the first draft. A wide range of individuals and groups reviewed the first draft between January 2005 and the Campus Planning Committee's public hearing on April 12, 2005. In addition to the public hearing, over twenty events and meetings were held including an open house, focus group meetings, a follow-up Advisory Group meeting, Campus Planning Committee workshops and meetings, key-party follow-up meetings, and presentations to the University Senate, Faculty Advisory Committee, and Space Advisory Group.

Following the public hearing, the Campus Planning Committee completed its review of the updated Plan, taking into consideration all input provided by interested parties. It forwarded a recommendation to approve the updated Plan to the university president, who provided final approval May 31, 2005. The final *Campus Plan* was submitted to the City of Eugene, which affirmed that the *Campus Plan* is in compliance with the *Metropolitan Area General Plan* on July 12, 2005.

Subsequent amendments followed the Plan amendment process (refer to Appendix K).

Appendix G: Historic Standards for Rehabilitation

Secretary of the Interior's Standards for Rehabilitation (Department of Interior regulations, 36 CFR 67)

1. A property shall be used for its historic purpose or be placed in a new use that requires minimal change to the defining characteristics of the building and its site and environment.
2. The historic character of a property shall be retained and preserved. The removal of historic materials or alteration of features and spaces that characterize a property shall be avoided.
3. Each property shall be recognized as a physical record of its time, place, and use. Changes that create a false sense of historical development, such as adding conjectural features or architectural elements from other buildings, shall not be undertaken.
4. Most properties change over time; those changes that have acquired historic significance in their own right shall be retained and preserved.
5. Distinctive features, finishes, and construction techniques or examples of craftsmanship that characterize a property shall be preserved.
6. Deteriorated historic features shall be repaired rather than replaced. Where the severity of deterioration requires replacement of a distinctive feature, the new feature shall match the old in design, color, texture, and other visual qualities and, where possible, materials. Replacement of missing features shall be substantiated by documentary, physical, or pictorial evidence.
7. Chemical or physical treatments, such as sandblasting, that cause damage to historic materials shall not be used. The surface cleaning of structures, if appropriate, shall be undertaken using the gentlest means possible.
8. Significant archaeological resources affected by a project shall be protected and preserved. If such resources must be disturbed, mitigation measures shall be undertaken.
9. New additions, exterior alterations, or related new construction shall not destroy historic materials that characterize the property. The new work shall be differentiated from the old and shall be compatible with the massing, size, scale, and architectural features to protect the historic integrity of the property and its environment.
10. New additions and adjacent or related new construction shall be undertaken in such a manner that if removed in the future, the essential form and integrity of the historic property and its environment would be unimpaired.

Note: The associated Guidelines for Rehabilitating Historic Buildings are available on the National Park Service web site, <http://www.nps.gov/tps/standards/rehabilitation/rehab/index.htm>. The Guidelines describe how to apply the Standards.

Appendix H: Historic Resources

Summary of Historic Rankings and Designations for Open Spaces, Trees, Structures, and Buildings. Refer to Campus Planning website for a map and the most current list of Historic Resources. *(NOTE: This list does not include all individual landscape features such as educational and memorial trees, plaques, memorials and sculptures. Please contact Campus Planning and Facilities Management.)*

STRUCTURES	LOCATION	HISTORIC DESIGNATION
		OFFICIAL DESIGNATION
Dads' Gates	Dads' Gates Axis	National Register
Normal Gate	Dads' Gates Axis (nearby)	National Register
Howe Field Gates and Associated Wall and Fence	1601 University Street	

OPEN SPACES	HISTORIC DESIGNATION	
	UO RANKING	OFFICIAL DESIGNATION
13th Ave. Axis	Primary	
15th Ave. Axis	Tertiary	
Amphitheater Green	Non-Contributing	
Campus Plan 1914	Primary	
Dads' Gates Axis	Tertiary	National Register (part)
University Hall Walk Axis	Primary	National Landmark (part)
Emerald Axis	Non-Contributing	
Gerlinger Entrance Green	Primary	National Register
Gerlinger Field	Secondary	National Register
Johnson Lane Axis	Secondary	National Register (part)
Kincaid Green	Tertiary	
Knight Library Axis	Primary	National Register (part)
Memorial Quadrangle	Primary	National Register
Millrace		
Old Campus Quadrangle	Primary	National Landmark (part)
Onyx Axis	Tertiary	
Promenade	Non-Contributing	
Southwest Campus Axis	Tertiary	
Southwest Campus Green	Tertiary	
Straub Green	Secondary	
University Street Axis	Secondary	National Register (part)
Villard Hall Green	Primary	National Landmark (part)
Women's Memorial Quad (previously Pioneer Axis)	Primary	National Register

MAP NO.	TREES OF SPECIAL SIGNIFICANCE	LOCATION	HISTORIC DESIGNATION
	(NOT INCLUDING EDUCATIONAL TREES)		OFFICIAL DESIGNATION
1	Port orford cedar	(Collier House)	City Landmark
2	Sitka spruce	13th Avenue Axis	City Landmark
3	Douglas firs	15th Avenue Axis, Onyx Axis, Straub Hall Green	
4	Giant cryptomeria	Dads' Gates Axis	Landmark
5	Giant sequoia	Dads' Gates Axis	National Landmark
6	Black walnut	Dads' Gates Axis	National Landmark
7	Ohio buckeye	Dads' Gates Axis	
8	Smoothleaf elm	Dads' Gates Axis	National Landmark
9	Dawn redwood	Dads' Gates Axis	National Landmark
10	Douglas firs	University Hall Walk	National Landmark
11	Douglas fir	Emerald Axis	
12	Douglas fir	Gerlinger Field Green	National Register
13	Douglas firs	Kincaid Green	
14	European beech	Knight Library Axis	National Register
15	Black walnut	Knight Library Axis	National Register
16	Pyramidal English Oaks (8)	Memorial Quad	National Register
17	Condon oak	Old Campus Quad	National Landmark
18	European linden	Old Campus Quad	National Landmark
19	Big-leaf maple	Old Campus Quad	National Landmark
20	Threadleaf Japanese maple	Old Campus Quad	National Register
21	Sequoia	Old Campus Quad	National Landmark
22	Dawn redwood	Onyx Green	
23	Ponderosa pine	Southwest Campus Green	
24	Big-leaf maple	Straub Hall Green	
25	Coast redwoods	Straub Hall Green	
26	Sitka spruce	University Street Axis	National Register
26	Sitka spruce	University Street Axis	National Register
27	Grand fir	University Street Axis	City Landmark
28	Pin oaks	University Street Axis	
29	Ponderosa pines	Villard Hall Green	National Landmark
30	Douglas firs	Villard Hall Green	National Landmark
31	Scarlet Oaks	Women's Quadrangle	National Register

BUILDING NAME	NO.	ADDRESS	HISTORIC DESIGNATION	
			UO RANKING	UO RANKING
AGATE HALL	147	1787 Agate St.	Secondary	
AGATE HOUSE	148	1795 Agate St.	Non-Contributing	
ALLEN (ERIC W.) HALL	17	1020 University St.	Tertiary	
ANSTETT HALL	3	965 E. 13th Ave.	Secondary	
BEAN COMPLEX	68,69	1741 E. 15th Ave.	Non-Contributing	

BUILDING NAME	NO.	ADDRESS	HISTORIC DESIGNATION	
			UO RANKING	OFFICIAL DESIGNATION
BEALL HALL (see Frohnmayer Music Bldg)				
CARSON HALL	76	1320 Beech St.	Tertiary	
CASCADE ANNEX (east)	28B	1264 Franklin Blvd.	Non-Contributing	
CASCADE ANNEX (west)	28A	1254 Franklin Blvd.	Non-Contributing	
CHAPMAN HALL	6	990 E. 13th Ave.	Primary	
CLINICAL SERVICES BUILDING	29	901 E. 18th Ave.	Non-Contributing	
COLLIER HOUSE	81	1170 E. 13th Ave.	Primary	City Landmark
COLUMBIA HALL	36	1215 E. 13th Ave.	Tertiary	
COMPUTING CENTER	39	1225 Kincaid St.	Non-Contributing	
CONDON HALL	4	1321 Kincaid St.	Primary	
COTTRELL (GEORGE) HOUSE	817	1060 Skyline Blvd. SW, Portland		
CREW/CLUB SPORTS	520	1757 E. 17th Ave.	Tertiary	
UNIVERSITY HALL	5	1201 Old Campus Ln.	Primary	National Landmark
EARL (VIRGIL D.) HALL COMPLEX	73	1323 E. 15th Ave.	Non-Contributing	
EDUCATION A (east)	7	1580 Kincaid St.	Secondary	
EDUCATION B (west)	7	1571 Alder St.	Secondary	
EDUCATION ANNEX	48	922 E. 16th St.	Tertiary	
ERB MEMORIAL UNION	33	1395 University St.	Secondary	
ESSLINGER (ARTHUR A.) HALL	23	1525 University St.	Tertiary	
FACILITIES SERVICES EXT. TEAM	593	1670 Columbia St.	Tertiary	
FENTON HALL	19	1021 E. 13th Ave.	Secondary	
FRIENDLY HALL	9	1161 E. 13th Ave.	Primary	
FROHNMEYER MUSIC	25	961 E. 18th Ave.	Secondary	
GERLINGER ANNEX	62	1484 University St.	Non-Contributing	
GERLINGER HALL	11	1468 University St.	Primary	National Register
HAMILTON HALL COMPLEX (east)	85	1365 Agate St.	Non-Contributing	
HAMILTON HALL COMPLEX (west)	84	1365 Agate St.	Non-Contributing	
HENDRICKS HALL	71	1408 University St.	Primary	National Register
HUESTIS HALL	40	1425 E. 13th Ave.	Non-Contributing	
J. SCHNITZER MUSEUM OF ART	24	1430 Johnson Ln.	Primary	National Register
JOHNSON HALL	16	1098 E. 13th Ave.	Primary	National Register
KLAMATH HALL	38	1370 Franklin Blvd.	Non-Contributing	
KNIGHT LIBRARY	18	1501 Kincaid St.	Primary	National Register
LAWRENCE HALL	1	1190 Franklin Blvd.	Tertiary	
McARTHUR COURT	20	1601 University St.	Primary	
McKENZIE HALL	30	1101 Kincaid St.	Secondary	
McMORRAN HOUSE	80	2315 McMorran St.	Primary	
MILITARY SCIENCE	87B, 87C	1679 Agate St.	Non-Contributing	
MILLER THEATRE COMPLEX				
MOSS HOUSE	607	1511 Moss St.	Tertiary	
ONYX BRIDGE	37	1318 Franklin Blvd.	Non-Contributing	
OREGON HALL	42	1585 E. 13th Ave.	Non-Contributing	
PACIFIC HALL	35	1025 University St.	Non-Contributing	
PETERSON HALL	22	935 E. 13th Ave.	Secondary	
PRINCE LUCIEN CAMPBELL HALL	8	1415 Kincaid St.	Non-Contributing	
ROMANIA	180	2020 Franklin Blvd.	Tertiary	National Register
STRAUB (JOHN) MEMORIAL HALL	72	1451 Onyx St.	Secondary	
SUSAN CAMPBELL HALL	75	1431 Johnson Ln.	Primary	National Register
UNIVERSITY HEALTH AND COUNSELING	14	1590 E. 13th Ave.	Non-Contributing	
VILLARD HALL	31	1109 Old Campus Ln.	Primary	National Landmark
VOLCANOLOGY	15	1255 E. 13th Ave.	Secondary	
WALTON (JOSHUA J.) HALL COMPLEX	77, 78	1595 E. 15th Aven.	Non-Contributing	
WATZEK HOUSE	818	1061 Skyline Blvd. SW, Portland	Primary	National Landmark

BUILDING NAME	NO.	ADDRESS	HISTORIC DESIGNATION	
			UO RANKING	OFFICIAL DESIGNATION
UNIVERSITY HEALTH AND COUNSELING	14	1590 E. 13th Ave.	Non-Contributing	
VILLARD HALL	31	1109 Old Campus Ln.	Primary	National Landmark
VOLCANOLOGY	15	1255 E. 13th Ave.	Secondary	
WALTON (JOSHUA J.) HALL COMPLEX	77, 78	1595 E. 15th Ave.	Non-Contributing	
WATZEK HOUSE	818	1061 Skyline Blvd. SW, Portland	Primary	National Landmark

EAST CAMPUS HOUSING		
ADDRESS	NO.	HISTORIC DESIGNATION
		UO RANKING
1857 E. 17th Ave.	531	Tertiary
1858 E. 17th Ave.	578	Tertiary
1727 Columbia St.	511	Tertiary
1728 Columbia St.	553	Tertiary
1748 Columbia St.	627	Tertiary
1786 Columbia St.	569	Tertiary
1798 Columbia St.	524	Tertiary
1800 Columbia St.	630	Non-Contributing
1804 Columbia St.	560	Tertiary
1491 Moss St.	554	Tertiary
1709 Moss St.	610	Tertiary
1790 Moss St.	573	Tertiary
1795 Moss St.	588	Non-Contributing
1802 Moss St.	530	Tertiary
1822 Moss St.	557	Tertiary
1838 Moss St.	529	Tertiary
1848 Moss St.	589	Tertiary
1480 Villard St.	575	Tertiary
1498 Villard St.	563	Tertiary
1528 Villard St.	503	Tertiary
1560 Villard St.	542	Tertiary
1572 Villard St.	515	Tertiary
1584 Villard St.	576	Non-Contributing
1598 Villard St.	556	Tertiary
1602 Villard St.	548	Non-Contributing
1618 Villard St.	571	Tertiary
1630 Villard St.	551	Tertiary
1692 Villard St.	604A	Tertiary
1694 Villard St.	604B	Tertiary
1734 Villard St.	549	Tertiary
1746 Villard St.	617	Non-Contributing
1778 Villard St.	609	Tertiary

Appendix I: University-owned Properties Outside Campus Boundaries (as of September 2022):

<i>Name</i>	<i>Address</i>
510 Oak	510 Oak Street, Eugene, OR 97401
942 Olive	942 Olive Street, Eugene, OR 97401
Aubrey Watzek House	1061 SW Skyline Boulevard, Portland, OR 97221
Autzen Stadium Complex (including Len Casanova Athletic Center, Ed Moshofsky Sports Center, PK Park, Hatfield-Dowlin Complex, and the Randy & Susie Pape Complex)	multiple
Baker Downtown Center	975 High Street, Eugene, OR 97401
Undeveloped Beachfront Lot; Tax Lot T29-R15-S01 BB TL 1400	Bandon, OR 97411
EC Cares	1500 W. 12th Avenue, Eugene, OR 97401
Fleet Services Building	3233 Franklin Boulevard, Eugene, OR 97403
George Cottrell House	1060 SW Skyline Boulevard, Portland, OR 97221
H. P. Barnhart Hall	1000 Patterson Street, Eugene, OR 97401
McMorran House (President's Residence)	2315 McMorran Drive, Eugene, OR 97403
Oregon Institute of Marine Biology	multiple
Parking Lot 52	1425 Walnut Street, Eugene, OR 97403
901 Franklin Parking Lot	901 Franklin Blvd., Eugene, OR 97403
Pine Mountain Observatory	multiple
Rainier Building	1244 Walnut Street, Eugene, OR 97403
Riley Hall	650 E. 11th Avenue, Eugene, OR 97401
Romania Property	2020 Franklin Boulevard, Eugene, OR 97403
The Shire: John Yeon Preserve for Landscape Studies	Columbia River Gorge, Washington
Spencer View Family Housing	multiple
Tree Tops	2237 Spring Boulevard, Eugene, OR 97403
UO Annex and storage building	876 E. 12th Avenue, Eugene, OR 97403
UO Portland Center (White Stag Block)	70 NW Couch St., Portland, OR 97209
UO Portland (Northeast Portland Campus)	2811 NE Holman St, Portland, OR 97211

Appendix J: City of Eugene Related Planning and Transportation Documents

The university hereby adopts by reference (*source: <https://www.eugene-or.gov/848/Studies-and-Adopted-Plans>*) the following as they pertain to the University of Oregon and adjacent lands as they now exist or may hereafter be amended:

1. *Envision Eugene Comprehensive Plan and UGB Adoption;*
2. *Metro Plan (Eugene-Springfield Metropolitan Area 1990 General Plan) and Diagram;*
3. *Eugene 2035 Transportation System Plan;*
4. *Central Lane Metropolitan Planning Organization 2045 Regional Transportation Plan, (source: <https://www.lcog.org/thempo/page/central-lane-metropolitan-planning-organization-2045-regional-transportation-plan>);*
5. *19th and Agate Special Area Study;*
6. *Downtown Riverfront Specific Area Plan;*

7. *Fairmount/University of Oregon Special Area Study*;
8. *Riverfront Park Study*;
9. *Walnut Station Specific Area Study*; and
10. *West University Refinement Plan*.

Appendix K: Summary of All Amendments to the Campus Plan (since 2005)

The Campus Plan includes amendments approved since 2005, which was the year that the 1991 Long Range Development Plan was replaced with the final version of the May 24, 2005 Campus Plan. It also includes editorial and typographical corrections intended to clarify the original intent of the document as well as updated facts and figures. The approved plan amendments address the following areas:

Related to the Framework Vision Project and the Southeast Campus Design Area - 2022

Amendments to pathways, densities, and design area descriptions, special conditions, and corresponding maps/images in the Southeast Campus Design Area.

Related to the area southeast of the Franklin Circle Design Area - 2022

Amendments to pathways, densities, and design area names and descriptions, special conditions, and corresponding maps/images in the design area previously known as Franklin Circle, expanding this design area, and renaming it the Franklin Triangle Design Area. This amendment incorporated the university's land southeast of the Franklin Circle Design Area.

Principle 1: Process and Participation, DAB (Design Advisory Board) - 2021

Amendments to Principle 1: Process and Participation construction projects participants description: Campus Planning and Facilities Management (CPFM). Addition of the DAB description and reference to the DAB in the Track B flow chart Design step.

Related to the area southeast of the Jaqua Triangle Design Area - 2021

Amendments to the open-space framework designated open spaces, pathways, densities, and design area names and descriptions, special conditions, and corresponding maps/images in the design area previously known as Jaqua Triangle, expanding this design area, and renaming it the Athletics, Student Support, and Administration Design Area. This amendment incorporated the university's land southeast of the Jaqua Triangle Design Area, including the Matthew Knight Arena and Ford Alumni Center.

North of Franklin Boulevard - 2020-2021

Amendments to the UO campus boundary, open-space framework designated open spaces, pathways, an added form definition to open space types, densities, and design area descriptions, special conditions, and corresponding maps/images. The purpose of the amendments was to incorporate the university's land north of Franklin Boulevard into the Plan.

Density in Sub-area 36 of the East Campus Design Area - 2020

Amendment to the density in Sub-area 36 of the East Campus Design Area. This amendment increased the maximum allowed density in a timeframe necessary to accommodate the Housing Storage Facility Project.

Hamilton and Walton Residence Halls Transformation Project - 2019

Amendments to the open-space framework, densities, and design area special conditions in Student Housing and Northeast Central Campus Design Areas.

University of Oregon Model for Sustainable Development (OMSD) Update - 2018

This amendment provided an update to the OMSD based on data gathered since 2011. The Energy and LEED goal sections were amended and a social equity section was added to the People goal.

Bean Hall Addition and Renovation Project - 2016

Amended Open-space Framework, Densities, and Design Area Special Conditions in Student Housing Design Area. This density amendment also enhanced the open-space framework in the area between Bean Hall, Hamilton Hall, the Ford Alumni Center, and the Matthew Knight Arena per the Campus Physical Framework Vision Project.

Jane Sanders Softball Project - 2015

Amendments to density for the Southeast Campus Design Area. This amendment changes the maximum allowed density to accommodate the Jane Sanders Softball Stadium Project.

New Residence Hall Project (Kalapuya Ilihi) - 2015

Amendments to the maximum allowed density for the East Campus Design Area. This amendment changes the maximum allowed density to accommodate the New Residence Hall Project south of Global Scholar's Hall.

EMU Area Open-space Framework - 2014

Amendment to the open-space framework in the Northeast Central Campus Design Area. The EMU Expansion and Renovation Project resulted in expansion of the open-space framework in the surrounding area. A new open space - EMU Green - was established.

Central Kitchen East Campus Open-space Framework - 2013

Amendments to the open-space framework on East Campus. The Central Kitchen and Woodshop Project, which is located in the East Campus Area, triggered the requirement to prepare and adopt an open-space framework plan for the affected area (the block bounded by 17th and 19th Avenues and Columbia and Moss Streets).

Northeast Campus Maximum Allowed Density Technical Correction - 2013

Amendments to density for the Northeast Campus Design Area. This amendment accounts for recently updated existing building measurements. The technical correction affects the maximum allowed density in the Northeast Campus Design Area.

OMSD Incorporated - 2011

This amendment incorporates refinements to the University of Oregon Model for Sustainable Development.

Oregon Model for Sustainable Development - 2011

The amendments to the Sustainable Development Principle are designed to improve and replace the university's 2001 Sustainable Development Plan. The OMSD was adopted to clarify the university's focus and to strengthen best practices based upon current knowledge. It addresses the unique aspects of campus buildings and landscapes by focusing on what matters most: energy, water, and people.

East Campus Open-space Framework - 2010

Amendments to the open-space framework on East Campus. The Global Scholars Hall project triggered the requirement to prepare and adopt an open-space framework plan for the affected area.

Lewis Integrative Science Building Open-space Framework - 2009

Amendments to open-space Framework for the Northeast Campus Design Area. The LISB project triggered the need to amend the campus's open-space framework. This included amendments to the Science Green and Agate Street Entrance Green open spaces as well as the establishment of a new open space, Franklin Boulevard Axis.

Welcoming to All Pattern - 2009

Addition of a new pattern related to diversity and inclusion. This ensures that the issue of diversity is considered during the project design to help create a campus that is welcoming to all.

Historic Landscapes - 2008

Addition of a new Historic Landscapes pattern and principle refinement. This addresses processes for identifying and documenting historic landscapes. They provide a framework for making decisions about preferred preservation actions and future development.

Appendix L: Walking Circles - Additional Maps

